

YOUNG SOLUTION



YOUNG SOLUTION



100% MADE IN ITALY

design R&S Zalf e Roberto Gobbo

CRESCI CON NOI

camerette per tutte le età...

Soluzioni in crescita per tutte le età, bambini e bambine, ragazzi e ragazze, non legate alle mode e con la possibilità di essere ampliate e modificate nel tempo grazie a SCHEMA LIBERO, un progetto dove aggiungere in libertà nuovi elementi e MULTISPAZIO, un unico progetto per moltiplicare lo spazio.

Growing solutions for all ages, from little boys and girls to teenagers, with an evergreen design that goes beyond fashion and with the possibility to add on and rearrange the layout over time thanks to SCHEMA LIBERO, a project that allows to add new elements freely, and to MULTISPAZIO, a unique system that multiplies space.

Des solutions qui s'agrandissent pour tous les âges, les enfants, les adolescents, non tributaires des modes et avec la possibilité d'être amplifiées et modifiées dans le temps grâce à SCHEMA LIBERO, un projet dans lequel ajouter en toute liberté de nouveaux éléments et MULTISPAZIO, un projet unique pour multiplier l'espace.

Lösungen, die in jedem Alter mitwachsen, für Jungen und Mädchen sowie für Jugendliche, die modeunabhängig sind und im Laufe der Zeit erweitert und verändert werden können, dank SCHEMA LIBERO, einem Projekt, bei dem neue Elemente beliebig ergänzt werden können, und MULTISPAZIO, einem beispiellosen Projekt, um den Raum zu vervielfältigen.

Soluciones en desarrollo para todas las edades, niños y niñas, chicos y chicas, no vinculadas a las modas y con la posibilidad de ampliarse y modificarse con el tiempo gracias a SCHEMA LIBERO, un proyecto donde se añaden libremente nuevos elementos y MULTISPAZIO, un único proyecto para multiplicar el espacio.

TIPI
DA ZALF,
SEMPRE UN PÒ
SPECIALI...
TU CHE
TIPO SEI?



anni 04



anni 10



anni 16



anni 24+

SCHEMA LIBERO

Z476	pag. 54
Z566	pag. 50
Z761_Z762_Z763	pag. 08
Z764_Z765	pag. 16
Z786	pag. 24
Z789	pag. 30
Z796	pag. 60
Z797	pag. 44
Z798	pag. 38

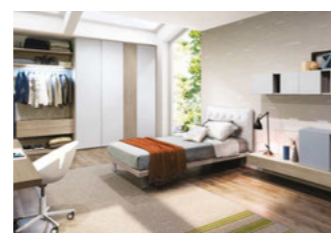

Z761_Z762_Z763 pag. 08

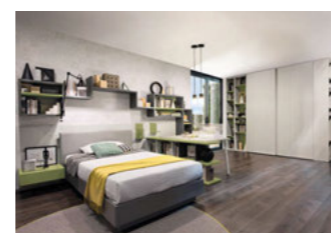

Z764_Z765 pag. 16

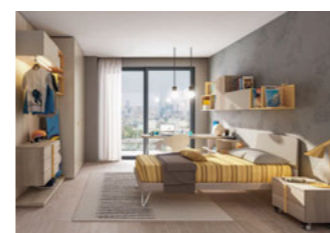

Z786 pag. 24

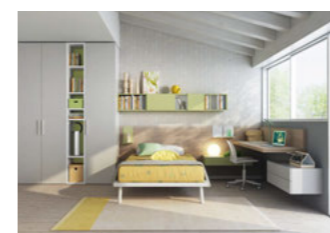

Z789 pag. 30

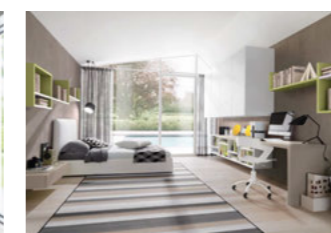

Z798 pag. 38



Z797 pag. 44



Z566 pag. 50



Z476 pag. 54



Z796 pag. 60

MULTISPAZIO

Z020	pag. 106
Z233	pag. 98
Z478	pag. 84
Z672	pag. 94
Z767	pag. 102
Z768	pag. 110
Z787	pag. 76
Z788	pag. 70
Z799	pag. 88



Z788 pag. 70

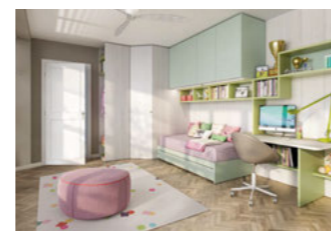

Z787 pag. 76



Z478 pag. 84

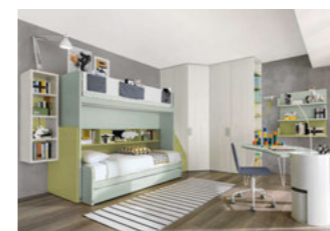

Z799 pag. 88



Z672 pag. 94

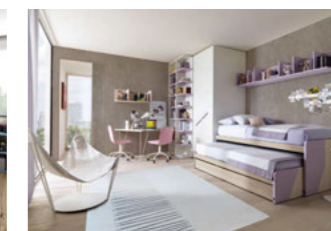

Z233 pag. 98



Z767 pag. 102



Z020 pag. 106

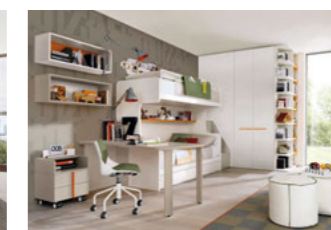

Z768 pag. 110

FOCUS

ARMADIO ANTA DIFFERENZIATA	pag. 14
LIBRERIA LINK SYSTEM	pag. 22
PANNELLATURA TEX	pag. 36
LIBRERIA LZ	pag. 48
LIBRERIA DOMINO	pag. 58
ZONA STUDIO	pag. 64
PANNELLATURA COVER	pag. 82
LETTO A CASTELLO SLIDE	pag. 92
CABINA ARMADIO	pag. 114
ARMADIO COMBI SYSTEM	pag. 116
ARMADIO MONOPOLI	pag. 118
IDENTITY CARD	pag. 120



ARMADIO ANTA DIFFERENZIATA pag. 14



LIBRERIA LINK SYSTEM pag. 22



PANNELLATURA TEX pag. 36

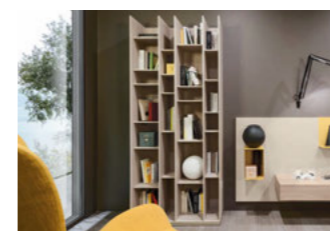

LIBRERIA LZ pag. 48



LIBRERIA DOMINO pag. 58



ZONA STUDIO pag. 64



PANNELLATURA COVER pag. 82

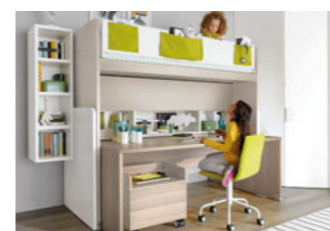

LETTO A CASTELLO SLIDE pag. 92



CABINA ARMADIO pag. 114

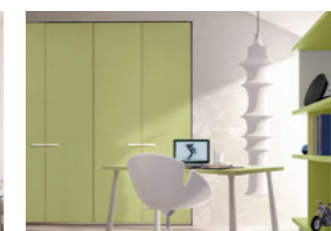

ARMADIO COMBI SYSTEM pag. 116

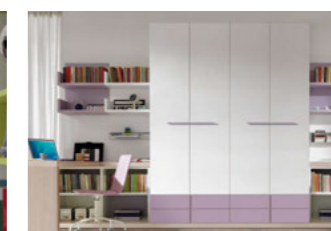

ARMADIO MONOPOLI pag. 118

UN PROGETTO DOVE AGGIUNGERE IN LIBERTÀ NUOVI ELEMENTI

SCHEMA LIBERO

Voglio una cameretta che cresca con me dove poter aggiungere in libertà nuovi elementi che servono a sognare, studiare, giocare e contenere tutti i miei libri, giochi, vestiti...

A project that allows to add new elements freely. I wish to have a bedroom that grows with me and in which I can freely add new elements in order to dream, study, play and arrange all my books, toys, clothes...

Un projet où ajouter librement de nouveaux éléments. Je veux une chambre qui grandisse avec moi où je peux ajouter en toute liberté de nouveaux éléments qui me permettent de rêver, d'étudier, de jouer et de contenir tous mes livres, jeux, vêtements...

Ein projekt, bei dem neue elemente beliebig angeordnet werden können. Ich möchte ein Kinderzimmer, das mit mir wächst und in dem ich beliebig alle Elemente ergänzen kann, die ich zum Träumen, Lernen, Spielen und zum Verstauen meiner Bücher, Spiele und Kleider benötige...

Un proyecto donde añadir libremente nuevos elementos. Deseo un dormitorio que crezca conmigo donde poder añadir libremente nuevos elementos que sirven para soñar, estudiar, jugar y contener todos mis libros, juegos, vestidos...

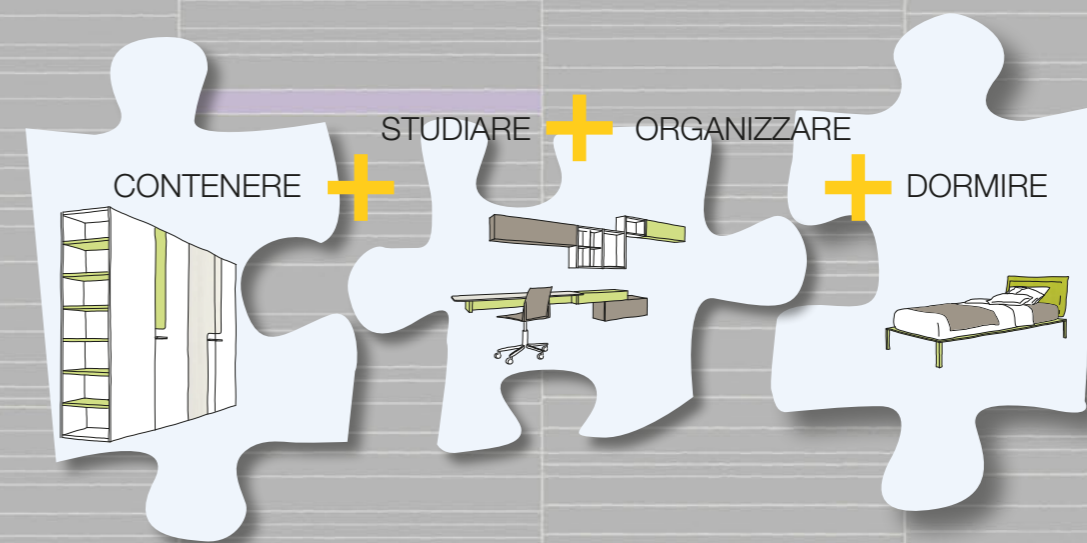



Z761 Z762 Z763 SCHEMA LIBERO

UN CARATTERE FRESCO E FRIZZANTE

A fresh, sparkling personality. Un caractère frais et dynamique.
Erfrischen und spritziger Charakter. Un carácter fresco y efervescente.

SCHEMA LIBERO
Z761

Forme dinamiche dal design leggero e sospeso per un alto livello estetico.

Airy, suspended design for dynamic shapes on another aesthetic plane.

Des formes dynamiques au design léger et suspendu pour un niveau esthétique élevé.

Dynamische Formen mit leichtem und schwerelosem Design für ein neues ästhetisches Niveau.

Formas dinámicas de diseño ligero y colgante para un alto nivel estético.



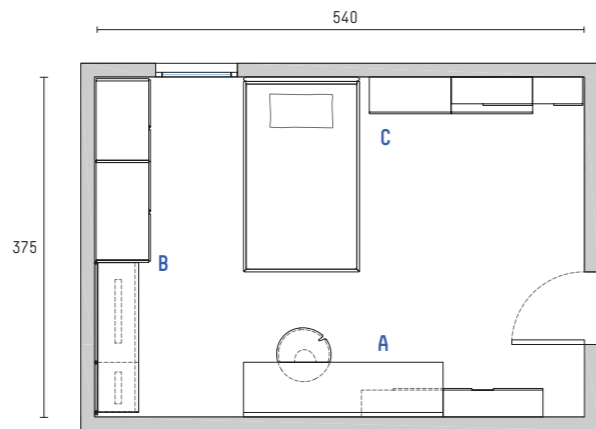

Z761, Z762 e Z763

- 1.Combi System: armadio ante battenti perla e termostrutturato rovere visone con maniglia Dap
- 2.Picà: pannellatura perla, mensole e cassettera termostrutturato rovere visone
- 3.Freedom: pensili in melaminico perla, avio e termostrutturato rovere visone
- 4.G45: pensili in termostrutturato rovere visone
- 5.Minimal: giroletto in termostrutturato rovere visone con testiera in ecopelle effetto capitonné
- 6.Minimal: scrittoio sospeso in termostrutturato rovere visone
- Bloom: sedia bianca

- 1.Combi System: hinged door wardrobe, pearl and thermo structured mink oak with Dap handle
- 2.Picà: pearl panelling, thermo structured mink oak shelves and drawer unit
- 3.Freedom: pearl, blue avio and thermo structured melamine wall units
- 4.G45: thermo structured mink oak wall units
- 5.Minimal: thermo structured mink oak bed frame with deep buttoned eco-leather headboard
- 6.Minimal: thermo structured mink oak hanging desk
- Bloom: white chair

- 1.Combi System: armoire portes battantes perle et thermostructuré chêne rouvre vison avec poignée Dap
- 2.Picà: lambrissage perle, tablettes et commode thermostructuré chêne rouvre vison
- 3.Freedom: éléments hauts en mélaminé perle, bleu pétrole et thermostructuré chêne rouvre vison
- 4.G45: éléments hauts en thermostructuré chêne rouvre vison
- 5.Minimal: cadre de lit en thermostructuré chêne rouvre vison avec tête en écocuier effet capitonné
- 6.Minimal: bureau suspendu en thermostructuré chêne rouvre vison
- Bloom: chaise blanche

- 1.Combi System: Drehtürenschränk in Perle und mit thermostrukturierter Oberfläche in Eiche Neuz, mit Griff Dap
- 2.Picà: Wandpaneel in Perle, Borde und Schubkastenelement mit thermostrukturierter Oberfläche in Eiche Neuz
- 3.Freedom: Hängeschränke aus Melamin in Perle, Fliegerblau und mit thermostrukturierter Oberfläche in Eiche Neuz
- 4.G45: Hängeschränke mit thermostrukturierter Oberfläche in Eiche Neuz
- 5.Minimal: Bettrahmen mit thermostrukturierter Oberfläche in Eiche Neuz, mit Kopfteil aus Kunstleder mit Capitonné-Verarbeitung
- 6.Minimal: hängender Schreibtisch mit thermostrukturierter Oberfläche in Eiche Neuz
- Bloom: weißer Stuhl

- 1.Combi System: armario con puertas batientes perla y de roble visón termoestructurado con tirador Dap
- 2.Picà: paneles perla, baldas y cajonera de roble visón termoestructurado
- 3.Freedom: muebles colgantes de melamina perla, azul avio y roble visón termoestructurado
- 4.G45: muebles colgantes de roble visón termoestructurado
- 5.Minimal: borde de la cama de roble visón termoestructurado con cabecero de ecopiel efecto capitonné
- 6.Minimal: escritorio colgante de roble visón termoestructurado
- Bloom: silla blanca

SCHEMA LIBERO
Z763

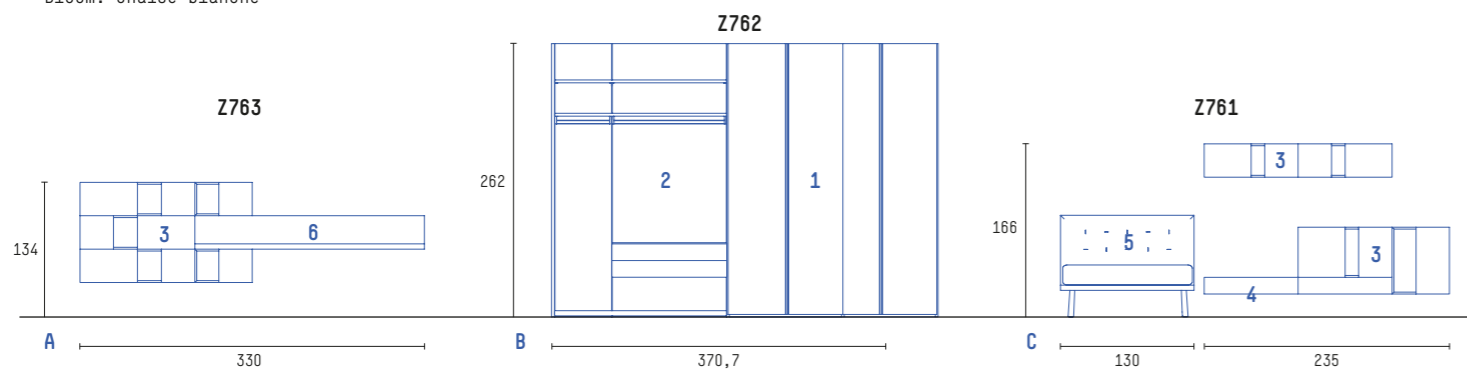



SCHEMA LIBERO
Z762



DAP

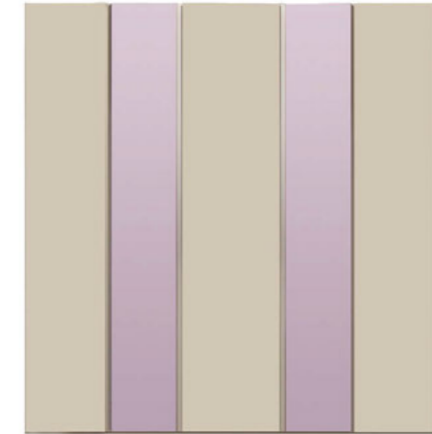

FOLD

FOCUS

ARMADIO COMBI SYSTEM ANTA BATTENTE A LARGHEZZA DIFFERENZIATA

Armadio Combi System. Anta battente Dap, Fold, Plan XL e Rime 18 a larghezza differenziata in aggiunta alle tipologie e dimensioni esistenti è compatibile con tutte le larghezze del vano interno.

Combi System wardrobe. Dap, Fold, Plan XL and Rime 18 hinged doors with differentiated widths in addition to existing types and dimensions are compatible with all internal widths.

Armoire Combi System. Porte battante Dap, Fold, Plan XL et Rime 18 à largeur différenciée en plus des typologies et dimensions existantes et compatible avec toutes les largeurs du compartiment interne.

Schrank Combi System. Drehtür Dap, Fold, Plan XL und Rime 18 in unterschiedlicher Breite zusätzlich zu den vorhandenen Modellen und Größen und kompatibel zu Innenflächen in allen Breiten.

Armario Combi System. Puerta batiente Dap, Fold, Plan XL y Rime 18 de ancho diferenciado además de los tipos y dimensiones existentes y compatibles con todos los anchos del compartimiento interior.



PLAN XL



RIME 18



Z764 Z765

VIVACE E CREATIVA

Vivacious and creative. Vivante et créative.
Lebhaft und kreativ. Llamativa y creativa.



SCHEMA LIBERO
Z764

Linguaggio compositivo in perfetto equilibrio tra design e funzione.
Compositions with perfectly balanced design and function.
Langage de composition en parfait équilibre entre design et fonction.
Anbauform mit perfektem Gleichgewicht aus Design und Funktion.
Lenguaje compositivo en perfecto equilibrio entre diseño y función.



FINITURE COMPOSIZIONE

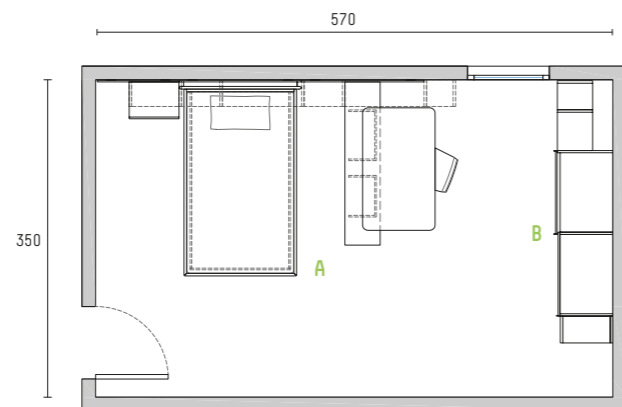

SCHEMA LIBERO
Z765

Z764 e Z765

- 1_Combi System: armadio con ante scorrevoli Dap in termostrutturato olmo ash con maniglie gola
- 2_Link System: libreria a terra e sospesa in termostrutturato olmo ash, ardesia e muschio
- 3_G45: pensili in melaminico muschio
- 4_Tex: pannellatura in termostrutturato olmo ash e testata imbottita
- 5_Bed45: letto in melaminico ardesia con meccanismo di sollevamento
- 6_Domino: libreria in melaminico bianco, ardesia e muschio
- 7_Web: scrittoio in termostrutturato olmo ash
- Strato: sedia imbottita

- 1_Combi System: thermo structured ash elm wardrobe with sliding doors Dap and profile handles
- 2_Link System: thermo structured ash elm, slate and moss bookcase on the ground and suspended
- 3_G45: moss melamine wall units
- 4_Tex: thermo structured ash elm panelling and upholstered headboard
- 5_Bed45: slate melamine bed with lifting mechanism
- 6_Domino: white, slate and moss melamine bookcase
- 7_Web: thermo structured ash elm desk
- Strato: upholstered chair

- 1_Combi System: armoire avec portes coulissantes Dap en thermostructuré olme ash avec poignées gorge
- 2_Link System: bibliothèque au sol et suspendu en thermostructuré olme ash, ardoise et mousse
- 3_G45: éléments hauts en mélaminé mousse
- 4_Tex: lambrisage en thermostructuré olme ash et tête rembourrée
- 5_Bed45: lit en mélaminé ardoise avec mécanisme de soulèvement
- 6_Domino: bibliothèque en mélaminé blanc, ardoise et mousse
- 7_Web: bureau en thermostructuré olme ash
- Strato: chaise rembourrée

- 1_Combi System: Schiebetürschrank Dap mit thermostrukturierter Oberfläche in Ulme Ash mit Griffen Gola
- 2_Link System: Bücherregal an Land und Hängender mit thermostrukturierter Oberfläche in Ulme Ash, Schiefer und Moos
- 3_G45: Hängeschränke aus Melamin in Moos
- 4_Tex: Wandpaneel mit thermostrukturierter Oberfläche in Ulme Ash und gepolstertem Kopfteil
- 5_Bed45: Bett aus Melamin in Schiefer mit Hebe Mechanismus
- 6_Domino: Bücherregal aus Melamin in Weiß, Schiefer und Moos
- 7_Web: Schreibtisch mit thermostrukturierter Oberfläche in Ulme Ash
- Strato: gepolsterter Stuhl

- 1_Combi System: armario con puertas correderas Dap de olmo ash termoestructurado con tiradores con perfil rebajado
- 2_Link System: libreria en tierra y suspendido de olmo ash termoestructurado, pizarra y musgo
- 3_G45: muebles colgantes de melamina musgo
- 4_Tex: paneles de olmo ash termoestructurado y cabecero mullido
- 5_Bed45: cama de melamina pizarra con mecanismo de elevación
- 6_Domino: libreria de melamina color blanco, pizarra y musgo
- 7_Web: escritorio de olmo ash termoestructurado
- Strato: silla mullida

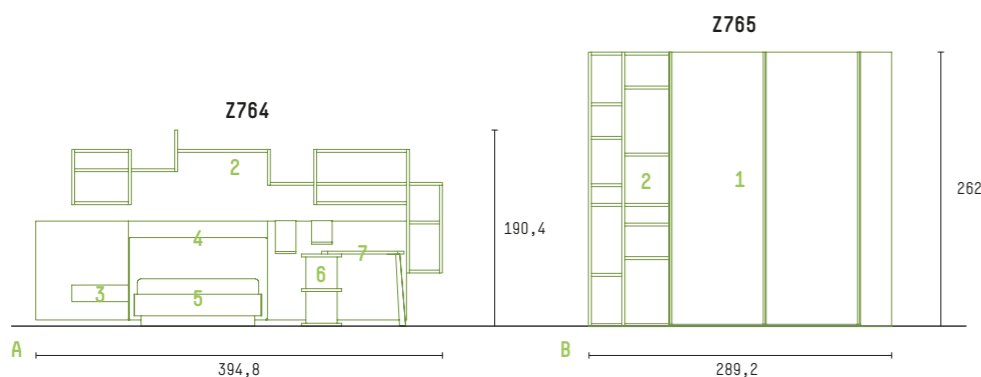



SCHEMA LIBERO
Z334



FOCUS

LINK SYSTEM SISTEMA VERSATILE E DINAMICO

Una modularità rigorosa permette a ciascuno di comporre soluzioni differenti per stile e colore, come librerie sospese disarticolate.

Link System a versatile and dynamic system. An entirely modular system that allows you to create unique combinations in terms of style and colour, such as disjointed wall bookcases.

Link System système versatile et dynamique. Une modularité rigoureuse permet à chacun de composer des solutions différentes par style et couleur, comme des bibliothèques suspendues désarticulées.

Link System vielseitiges und dynamisches system. Rigorose Modularität bietet jedem die Möglichkeit, Lösungen zu erstellen, die in Stil und Farbe unterschiedlich sind, wie beliebig anbaufähige hängende Bücherregale.

Link System sistema versatil y dinámico. Una modularidad rigurosa permite a cada uno componer distintas soluciones por estilo y color, como librerías colgantes, desarticuladas.





Z786 SCHEMA LIBERO

FREE STYLE ORGANIZZATO

Organised free style. Free style organised.
Organisierter Free Style. Free style organisiert.



SCHEMA LIBERO
Z786

Originali elementi dalla geometria semplice creano uno spazio elegante, colorato e personalizzato.

Simply styled, original elements create elegant space that's colourful and customised.

Des éléments originaux à la géométrie simple créent un espace élégant, coloré et personnalisé.

Originelle Elemente mit einfacher Geometrie schaffen einen eleganten, farbigen und individuellen Raum.

Elementos originales de geometría sobria crean un espacio elegante, coloreado y personalizado.



FINITURE COMPOSIZIONE

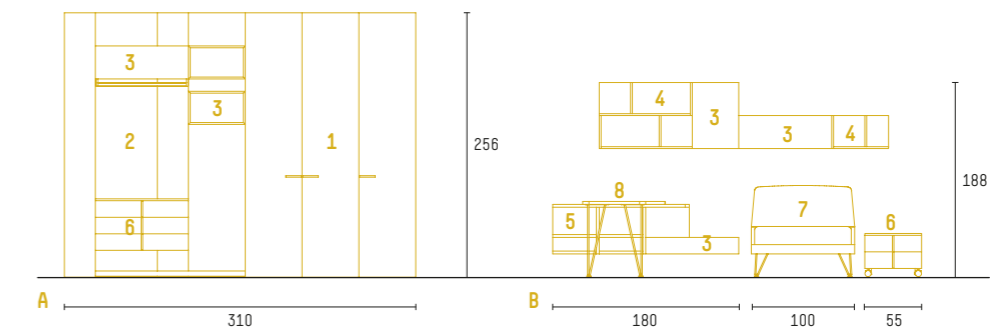

Z786

- 1.Monopoli: armadio ante battenti cashmere con maniglie Shanghai mango
- 2.Cover: pannellatura in termostrutturato olmo sand NT
- 3.G45: pensili in melaminico mango, cashmere e termostrutturato olmo sand NT
- 4.Unoeotto: pensili in melaminico mango e termostrutturato olmo sand NT
- 5.Link System: libreria sospesa in melaminico cashmere
- 6.Monopoli: cassetiera in termostrutturato olmo sand NT
- 7.Bandy: letto in cashmere e termostrutturato olmo sand NT e piedini bianchi
- 8.Stelo: scrittoio in termostrutturato olmo sand NT Well: sedia bianca

- 1.Monopoli: cashmere hinged door wardrobe with mango Shanghai handles
- 2.Cover: thermo structured sand elm NT panelling
- 3.G45: mango, cashmere and thermo structured sand elm NT wall units
- 4.Unoeotto: mango and thermo structured sand elm NT melamine wall units
- 5.Link System: cashmere melamine hanging bookcase
- 6.Monopoli: thermo structured sand elm NT drawer unit
- 7.Bandy: cashmere and thermo structured sand elm NT bed with white feet
- 8.Stelo: thermo structured sand elm NT desk Well: white chair

- 1.Monopoli: armoire portes battantes cashmere avec poignées Shanghai mangue
- 2.Cover: lambrissage en thermostructuré olme sand NT
- 3.G45: éléments hauts en mélaminé mangue, cashmere et thermostructuré olme sand NT
- 4.Unoeotto: éléments hauts en mélaminé mangue et thermostructuré olme sand NT
- 5.Link System: bibliothèque suspendue en mélaminé cashmere
- 6.Monopoli: commode en thermostructuré olme sand NT
- 7.Bandy: lit en cashmere et thermostructuré olme sand NT et pieds blancs
- 8.Stelo: bureau en thermostructuré olme sand NT Well: chaise blanche

- 1.Monopoli: Drehtürenschränk in Kaschmir mit Griffen Shanghai in Mango
- 2.Cover: Wandpaneel mit thermostrukturierter Oberfläche in Ulme Sand NT
- 3.G45: Hängeschränke aus Melamin in Mango, Kaschmir und mit thermostrukturierter Oberfläche in Ulme Sand NT
- 4.Unoeotto: Hängeschränke aus Melamin in Mango und mit thermostrukturierter Oberfläche in Ulme Sand NT
- 5.Link System: hängendes Bücherregal aus Melamin in Kaschmir
- 6.Monopoli: Schubkastenelemente mit thermostrukturierter Oberfläche in Ulme Sand NT
- 7.Bandy: Liege in Kaschmir, mit thermostrukturierter Oberfläche in Ulme Sand NT und mit weißen Füßen
- 8.Stelo: Schreibtisch mit thermostrukturierter Oberfläche in Ulme Sand NT Well: weißer Stuhl

- 1.Monopoli: armario con puertas batientes cashmere con tiradores Shanghai mango
- 2.Cover: paneles de olmo sand NT termoestructurado
- 3.G45: muebles colgantes de melamina mango, cashmere y olmo sand NT termoestructurado
- 4.Unoeotto: muebles colgantes de melamina mango y olmo sand NT termoestructurado
- 5.Link System: librería colgante de melamina cashmere
- 6.Monopoli: cajonera de olmo sand NT termoestructurado
- 7.Bandy: cama cashmere y de olmo sand NT termoestructurado y patas blancas
- 8.Stelo: escritorio de olmo sand NT termoestructurado Well: silla blanca

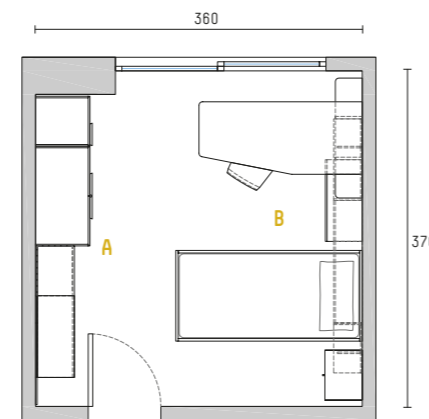



Z789 SCHEMA LIBERO

FUNZIONALE E ORDINATA

Neat and functional. Fonctionnelle et en ordre.
Funktional und geordnet. Funcional y ordenada.

SCHEMA LIBERO
Z789

La stanza dei sogni che soddisfa ogni situazione funzionale sfruttando opportunamente lo spazio.

A dream room that meets any functional situation by making maximum use of the space available.

La pièce de rêve qui satisfait toutes les situations fonctionnelles en exploitant au mieux l'espace.

Ein traumhaftes Zimmer, das alle funktionalen Anforderungen erfüllt, indem der vorhandene Raum optimal genutzt wird.

La habitación de los sueños que satisface cualquier situación funcional disfrutando el espacio de un modo adecuado.



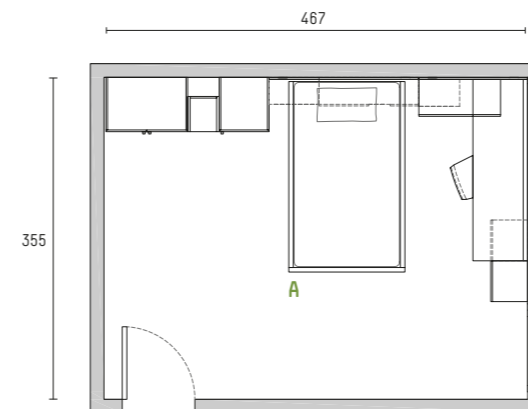

Z789

- 1_Monopoli: armadio ante battenti in melaminico perla con maniglie tipo F bianche
 - 2_Link System: libreria in melaminico bianco e muschio
 - 3_Freedom: pensili in melaminico bianco e muschio
 - 4_G45: pensili in melaminico perla e muschio
 - 5_Minimal: giroletto in melaminico bianco
 - 6_Tex: pannellatura in termostrutturato rovere visone
 - 7_Minimal: scrittoio sospeso in termostrutturato rovere visone
- Set: sedia bianca

- 1_Monopoli: pearl melamine hinged door wardrobe with white F type handle
 - 2_Link System: white and moss melamine bookcase
 - 3_Freedom: white and moss melamine wall units
 - 4_G45: pearl and moss melamine wall units
 - 5_Minimal: white melamine bed frame
 - 6_Tex: thermo structured mink oak panelling
 - 7_Minimal: thermo structured mink oak hanging desk
- Set: white chair

- 1_Monopoli: armoire portes battantes en mélaminé perle avec poignées type F blanche
 - 2_Link System: bibliothèque en mélaminé blanc et mousse
 - 3_Freedom: éléments hauts en mélaminé blanc et mousse
 - 4_G45: éléments hauts en mélaminé perle et mousse
 - 5_Minimal: cadre de lit en mélaminé blanc
 - 6_Tex: lambrisage en thermostructuré chêne rouvre vison
 - 7_Minimal: bureau suspendu en thermostructuré chêne rouvre vison
- Set: chaise blanche

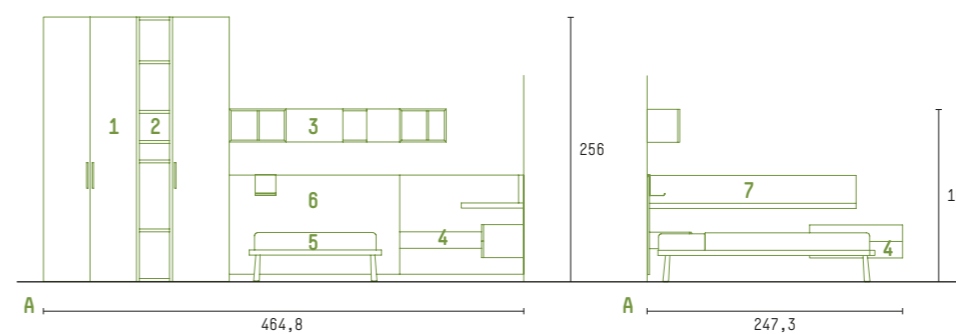



FOCUS

TEX SISTEMA PANNELLI TESSUTO E MELAMINICO

Pannellature capaci di creare importanti testate letto, rivestite anche in tessuto, con la possibilità di avere accessori e vani dove collocare libri e quaderni.

A creative and functional system. These panels create exclusive headboards with fabric upholstery and with the possibility to add accessories and compartments where you can store your books.

Système créatif et fonctionnel. Panneaux en mesure de créer d'importantes têtes de lit, également revêtues en tissu, avec la possibilité d'avoir des accessoires et des compartiments où ranger des livres et des cahiers.

Kreatives und Funktionales System. Auffallende Kopfteile für Betten aus Platten, auch mit Stoffbezug, mit Platz für Zubehör und mit Fächern, um Bücher und Hefte abzulegen.

Sistema creativo y funcional. Serie de paneles capaces de crear grandes cabeceros de cama, tapizados también de tejido, con accesorios y compartimentos disponibles donde colocar libros y cuadernos.



Z798 SCHEMA LIBERO

PROGETTATA PER IL FUTURO

Designed for the future. Projetée pour le futur.
Zukunftsorientierte Planung. Ideada para el futuro.



SCHEMA LIBERO
7798

Innovazione, concretezza e tanto spazio dedicato al contenimento in una soluzione assolutamente razionale.

Innovation, practicality and lots of space dedicated to storage in an extremely rational solution.

Innovant, concret et de nombreux espaces dédiés au rangement en une solution absolument rationnelle.

Greifbare Innovation mit viel Stauraum für eine absolut rationelle Lösung.

Innovación, concreción y mucho espacio destinado a contener en una solución totalmente funcional.

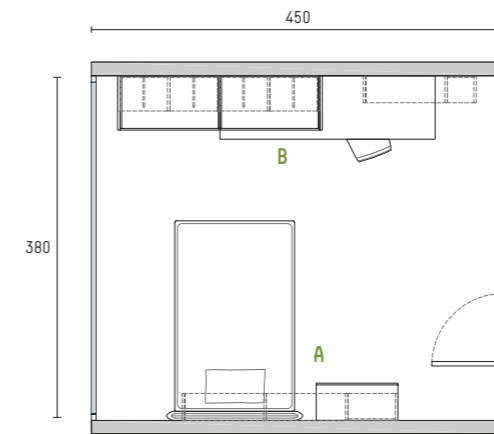

Z798

- 1.Monopoli: armadio a ponte con ante battenti bianche
- 2.Link System: libreria sospesa bianca e muschio
- 3.Minimal: scrittoio selce
- 4.G45: comodino selce
- 5.Lov: letto in tessuto shabby bianco by Désirée
- Elipse: sedia bianca

- 1.Monopoli: bridge wardrobe with hinged doors in white
- 2.Link System: wall bookcase in white and moss
- 3.Minimal: writing desk in flint
- 4.G45: flint night stand
- 5.Lov: bed in shabby white fabric by Désirée
- Elipse: white chair

- 1.Monopoli: armoire à pont avec portes battantes blanches
- 2.Link System: bibliothèque suspendue blanche et musc
- 3.Minimal: bureau en silex
- 4.G45: table de nuit silex
- 5.Lov: lit en tissu shabby blanc by Désirée
- Elipse: chaise blanc

- 1.Monopoli: Überbauschrank mit Drehtüren in Weiß
- 2.Link System: hängendes Bücherregal in Weiß und Moss
- 3.Minimal: Schreibtisch mit Kiesel
- 4.G45: Nachttisch Kiesel
- 5.Lov: Bett aus Stoff Shabby in Weiß by Désirée
- Elipse: Stuhl Weiß

- 1.Monopoli: armario puente con puertas batientes blancas
- 2.Link System: librería colgante blanca y musgo
- 3.Minimal: escritorio de silex
- 4.G45: mesita de noche silex
- 5.Lov: cama de tejido shabby blanco by Désirée
- Elipse: silla blanca

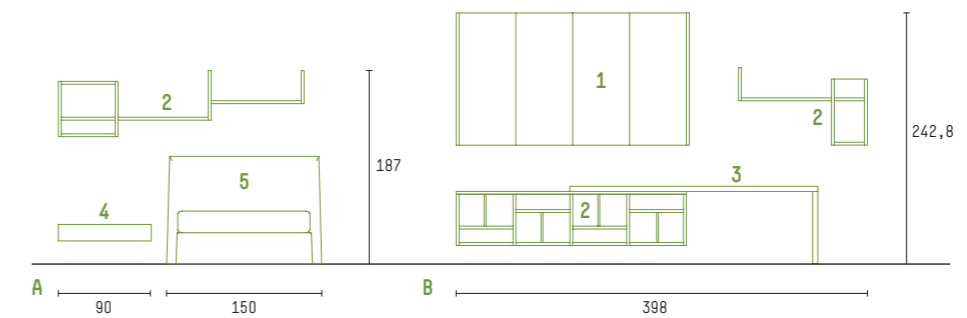



Z797 SCHEMA LIBERO

PRATICO E UN PÒ SPECIALE

Practical and a just a bit special. Pratique et un peu spécial.
Praktisch und etwas speziell. Cómodo y un poco especial.

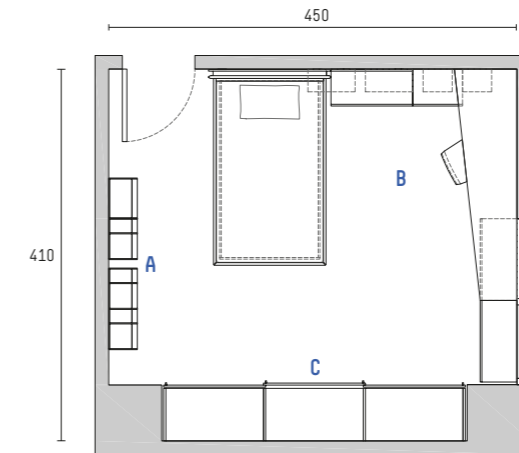

Z797

- 1_Combi System: armadio ante scorrevoli cashmere con maniglie Shanghai cashmere
- 2_G45: basi sospese in melaminico cashmere
- 3_LZ: libreria in melaminico cashmere
- 4_Shape: pensili in metallo verniciato bianco e avio
- 5_Bed45: letto sommier con box contenitore in melaminico cashmere
- 6_Tex: testata in termostrutturato olmo sand NT e tessuto sfoderabile
- 7_Minimal: scrittoio in termostrutturato olmo sand NT
Set: sedia tortora

- 1_Combi System: wardrobe with cashmere sliding doors, Shanghai handles cashmere
- 2_G45: wall base units in cashmere melamine
- 3_LZ: bookcase in cashmere melamine
- 4_Shape: wall units in metal, varnished white and avio
- 5_Bed45: storage bed in cashmere melamine
- 6_Tex: headboard in thermo structured elm sand NT and removable fabric
- 7_Minimal: writing desk in thermo structured elm sand NT
Set: dove chair

- 1_Combi System: armoire portes coulissantes cashmere avec poignées Shanghai cashmere
- 2_G45: éléments bas suspendus en mélaminé cashmere
- 3_LZ: bibliothèque en mélaminé cashmere
- 4_Shape: éléments hauts en métal verni blanc et bleu avio
- 5_Bed45: lit espace de rangement en mélaminé cashmere
- 6_Tex: tête en thermostructuré olme sand NT et tissu déhoussable
- 7_Minimal: bureau en thermostructuré olme sand NT
Set: chaise tourterelle

- 1_Combi System: Schiebetürenschrank in Kaschmir und Griffe Shanghai in Kaschmir
- 2_G45: hängende Unterschränke aus Melamin in Kaschmir
- 3_LZ: Bücherregal aus Melamin in Kaschmir
- 4_Shape: Hängeschränke aus Metall in Lack Weiß und Avio blau
- 5_Bed45: Bett mit Bettkasten aus Melamin in Kaschmir
- 6_Tex: Kopfteil mit thermostrukturierter Oberfläche in Ulme sand NT und abziehbarem Stoffbezug
- 7_Minimal: Schreibtisch mit thermostrukturierter Oberfläche in Ulme sand NT
Set: Stuhl Turteltaube

- 1_Combi System: armadio con puertas correderas cashmere y tiradores Shanghai cashmere
- 2_G45: muebles bajos colgantes de melaminico cashmere
- 3_LZ: libreria de melaminico cashmere
- 4_Shape: muebles colgantes de metal pintado blanco y azul avio
- 5_Bed45: cama contenedor de melaminico cashmere
- 6_Tex: Cabecero de termoestructurado de olmo sand NT y tejido desenfundable
- 7_Minimal: escritorio de termoestructurado de olmo sand NT
Set: silla tórtola

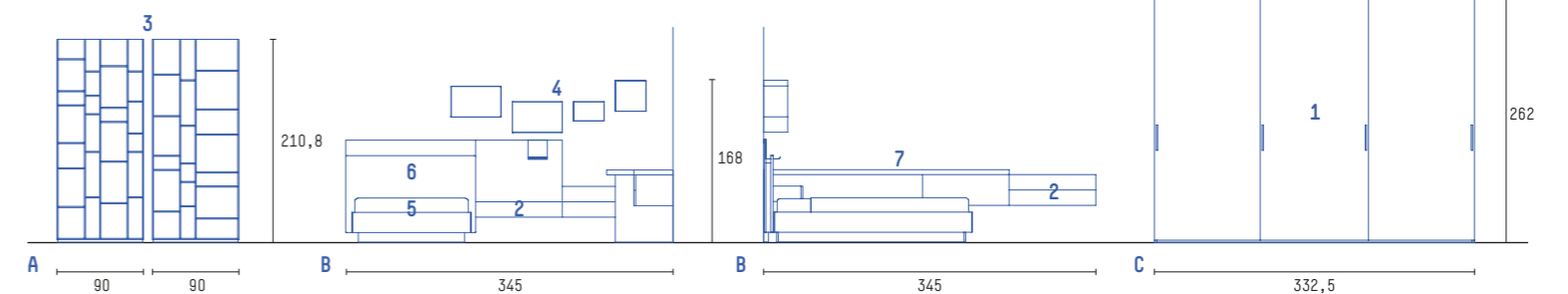



bianco white cashmere cashmere selce flint perla pearl ardesia slate mango mango olmo ash ash elm olmo sand sand elm rovere visone mink oak

FOCUS

LIBRERIA LZ

DESIGN MARC SADLER

La libreria costituita da due diversi moduli da 90 cm. ed un modulo da 60 cm, accostabili a piacere, può essere appoggiata a muro o posizionata a centro stanza grazie alla schiena rivestita nello stesso materiale. Realizzata in melaminico sp.12 mm è disponibile in 9 colori: bianco, cashmere, selce, perla, ardesia, mango, olmo ash, olmo sand e rovere visone.

This bookcase features two different modules of 90 cm and one module of 60 cm, that can be freely placed next to one another. The bookcase can be wall mounted or free standing at the centre of the room thanks to its back, made of the same material. It is in melamine 12 mm thick, available in 9 colours: white, cashmere, flint, pearl, slate, mango, elm ash, elm sand and mink oak.

La bibliothèque constituée par deux modules différents de 90 cm. et un module de 60 cm, assemblables selon son gré, peut être posée contre le mur ou positionnée au centre de la pièce grâce au dos revêtu dans le même matériau. Réalisée en mélaminé ép.12mm, elle est disponible dans 9 couleurs: blanc, cashmere, silex, perle, ardoise, mangue, orme ash, orme sand et chêne vison.

Das Bücherregal besteht aus zwei verschiedenen 90 cm breiten Modulen und einem 60 cm breiten Modul, die beliebig angebaut werden können. Es kann an der Wand oder in der Raummitte aufgestellt werden, da die Rückwand mit dem gleichen Material beschichtet ist. Hergestellt aus Melamin St.12mm und erhältlich in 9 Farben: Weiß, Kaschmir, Kiesel, Perle, Schiefer, Mango, Ulme Ash, Ulme Sand und Eiche Nerz.

La libreria constituida por dos distintos módulos de 90 cm y por un módulo de 60 cm, accimables a gusto, puede apoyarse en la pared o posicionarse en el centro de la habitación gracias a la tcasera revestida del mismo material. Realizada en melaminico de 12 mm de esp. está disponible en 9 colores: blanco, cashmere, silex, perla, pizacra, mango, olmo ash, olmo sand y roble vison.





Z566 SCHEMA LIBERO

ROMANTICA E ALLEGRA

Romantic and cheerful. Romantique et joyeuse.
Romantisch und beschwingt. Romántica y alegre.

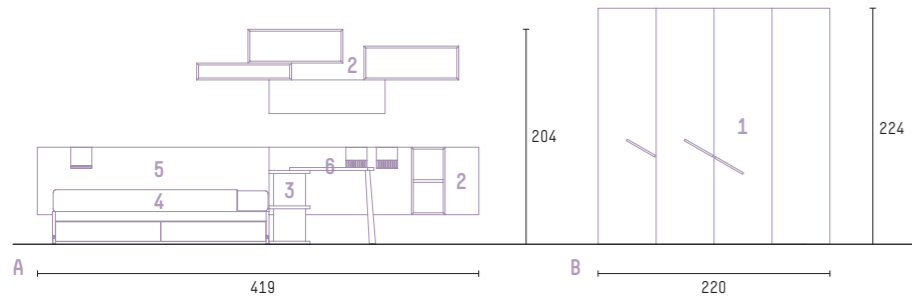

Z566

1.Monopoli: armadio in melaminico bianco, maniglie Shanghai lilla e colonna terminale melaminico bianca e lilla
 2.G45: pensili chiusi e a giorno in melaminico selce, bianco, lilla e termocutturato olmo sand NT
 3.Domino: libreria bassa in melaminico selce, lilla e bianco
 4.Plain: letto in melaminico selce e termocutturato olmo sand NT
 5.Tex: testate a parete in lilla e termocutturato olmo sand NT
 6.Web: scrittoio in appoggio in termocutturato olmo sand NT
 Bloom: sedia con scocca bianca e cuscino imbottito

1.Monopoli: wardrobe in white melamine, lilac Shanghai handles and end tall unit in white and lilac melamine
 2.G45: wall units, closed and with open shelf, in melamine with colours flint, white, lilac and thermo structured elm sand NT
 3.Domino: low bookcase in flint, lilac and white melamine
 4.Plain: bed in flint melamine and thermo structured elm sand NT
 5.Tex: wall headboard in lilac and thermo structured elm sand NT
 6.Web: writing desk in thermo structured elm sand NT
 Bloom: chair with a white structure and a padded cushion

1.Monopoli: armoire en mélaminé blanc poignées Shanghai mauve et colonne terminaison mélaminé blanc et mauve
 2.G45: éléments hauts fermés et ouverts en mélaminé silex, blanc, mauve et thermostructuré ocme sand NT
 3.Domino: bibliothèque bassa in mélaminé silex, mauve et blanche
 4.Plain: lit mélaminé silex et thermostructuré ocme sand NT
 5.Tex: têtes au mur en mauve et thermostructuré ocme sand NT
 6.Web: bureau au sol en thermostructuré ocme sand NT
 Bloom: chaise avec coque en polyéthylène blanche et coussin rembourcé

1.Monopoli: Schrank aus Melamin in Weiß, Griffe Shanghai in Lila und Abschluss-Hochschrank aus Melamin in Weiß und Lila
 2.G45: geschlossene und offene Hängeschränke aus Melamin in Kiesel, Weiß, Lila und mit thermostrukturierter Oberfläche in Ulme Sand NT
 3.Domino: flaches Bücherregal aus Melamin in Kiesel, Lila und Weiß
 4.Plain: Bett aus Melamin in Kiesel mit thermostrukturierter Oberfläche in Ulme Sand NT
 5.Tex: Kopfteile an der Wand in Lila mit thermostrukturierter Oberfläche in Ulme Sand NT
 6.Web: aufgesetzter Schreibtisch mit thermostrukturierter Oberfläche in Ulme Sand NT
 Bloom: Stuhl mit Sitzschale in Weiß und gepolstertem Kissen

1.Monopoli: armario de melaminico blanco con tiradores Shanghai lila y columna terminal de melaminico blanca y lila
 2.G45: muebles colgantes cerrados y abiertos de melaminico silex, blanco, lila y de termoestructurado de olmo sand NT
 3.Domino: libreria baja de melaminico silex, lila y blanco
 4.Plain: cama de melaminico silex y de termoestructurado de olmo sand NT
 5.Tex: cabeceros de pared color lila y de termoestructurado de olmo sand NT
 6.Web: escritorio de apoyo de termoestructurado de olmo sand NT
 Bloom: silla con armazón blanco y cojín acolchado

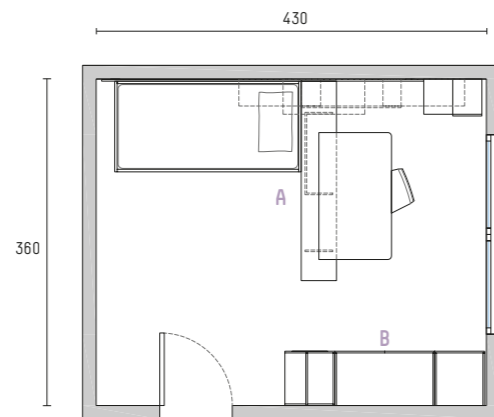



Z476 SCHEMA LIBERO

TUTTO RITMO E VOLUME

Rhythm and volume galore. Tout en rythme et volume.
Viel Rhythmus und Volumen. Todo ritmo y volumen.

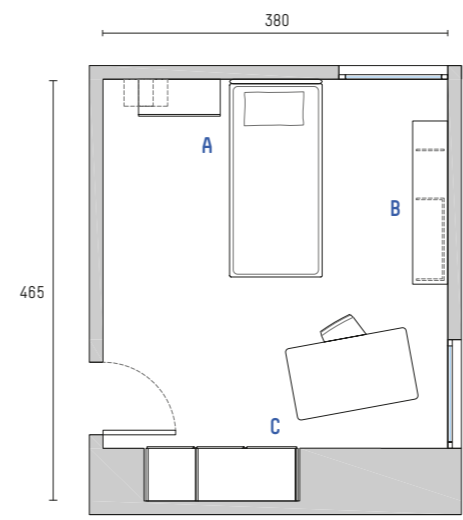

Z476

- 1.Combi System: armadio con ante battenti Fold in termostrutturato olmo sand NT e maniglie gola in alluminio verniciate avio
- 2.Domino: libreria bianca, avio e termostrutturato olmo sand NT
- 3.G45: pensili bianco, avio e termostrutturato olmo sand NT
- 4.Web: letto imbottito rivestito in tessuto sfoderabile
- 5.Web: scrittoio con piano in melaminico avio e gambe in legno
- Bloom: sedia con scocca bianca e cuscino imbottito

- 1.Combi System: wardrobe with hinged doors Fold in thermo structured elm sand NT and aluminium grip profile handles with blue avio varnish
- 2.Domino: bookcase in colours white, blue avio and thermo structured elm sand NT
- 3.G45: wall units in white, blue avio and thermo structured elm sand NT
- 4.Web: padded bed with upholstery in removable fabric
- 5.Web: writing desk with top in blue avio melamine and wooden legs in thermo structured elm sand NT
- Bloom: chair with a white structure and a padded cushion

- 1.Combi System: armoire avec portes battantes Fold en thermostructuré olme sand NT et poignées gorge en aluminium vernies bleu avio
- 2.Domino: bibliothèque blanche, bleu avio et thermostructuré olme sand NT
- 3.G45: éléments hauts blanc, bleu avio et thermostructuré olme sand NT
- 4.Web: lit rembourré revêtu en tissu déhoussable
- 5.Web: bureau avec plateau en mélaminé bleu avio et piètements en bois thermostructuré olme sand NT
- Bloom: chaise avec coque en polyéthylène blanche et coussin rembourré

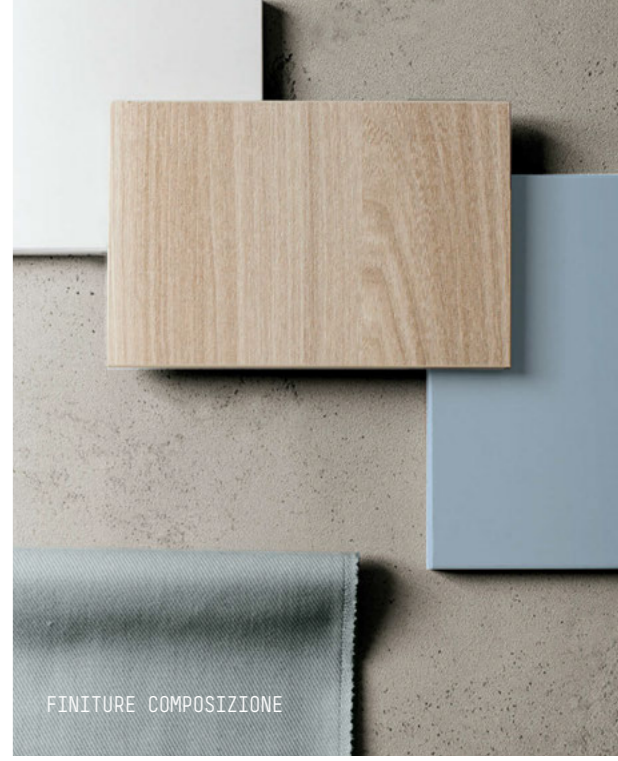
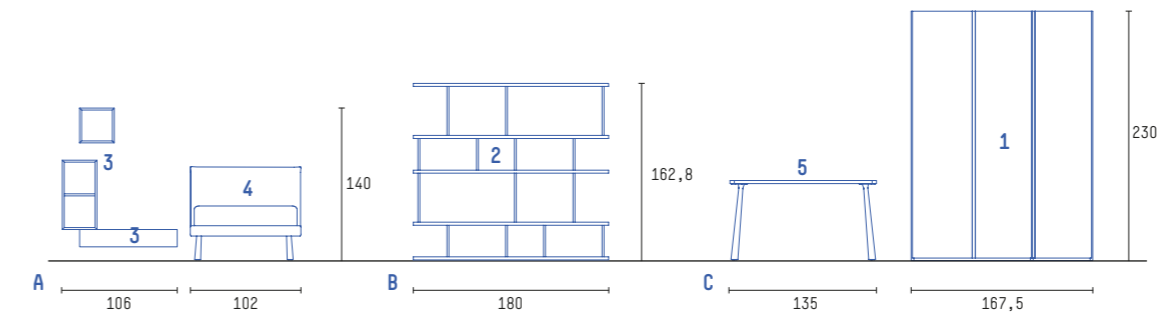

- 1.Combi System: Drehtürschrank Fold mit thermostrukturierter Oberfläche in Ulme Sand NT und Griff Gola aus Aluminium in Lack Avioblau
- 2.Domino: Bücherregal in Weiß und Avioblau mit thermostrukturierter Oberfläche in Ulme Sand NT
- 3.G45: Hängeschränke in Weiß und Avioblau mit thermostrukturierter Oberfläche in Ulme Sand NT
- 4.Web: Polsterbett mit abziehbarem Stoffbezug
- 5.Web: Schreibtisch mit Platte aus Melamin in Avioblau und Beinen aus Holz mit thermostrukturierter Oberfläche in Ulme Sand NT
- Bloom: Stuhl mit Sitzschale in Weiß und gepolstertem Kissen

- 1.Combi System: armario con puertas batientes Fold de termoestructurado de olmo sand NT y tiradores en perfil rebajado de aluminio pintados azul avio
- 2.Domino: librería blanca, azul avio y de termoestructurado de olmo sand NT
- 3.G45: muebles colgantes color blanco, azul avio y de termoestructurado de olmo sand NT
- 4.Web: cama mullida tapizada de tejido desenfundable
- 5.Web: escritorio con sobre melamínico azul avio y patas de termoestructurada de madera de olmo sand NT
- Bloom: silla con armazón blanco y cojín acolchado





FOCUS

DOMINO LIBRERIA A PARETE O BIFACCIALE

Larghezza 90, 110, 135, 165, 180, 220, 270 cm
con profondità 38,8 cm. Multipli in altezza di 32 e 48 cm.

Wall mounted or double-sided bookcase. Width 90, 110, 135, 165, 180,
220, 270 cm with depth 38,8 cm. Height: multiples of 32 and 48 cm.

Bibliothèque murale ou double-face. Largeur 90, 110, 135, 165, 180,
220, 270 cm avec profondeur 38,8 cm. Multiples en hauteur de 32 et 48 cm.

Bücherregal an der Wand oder doppelseitig. Breite 90, 110, 135, 165, 180,
220, 270 cm mit Tiefe 38,8 cm. In der Höhe als Vielfaches von 32 und 48 cm.

Librería de pared o de dos caras. de 90, 110, 135, 165, 180, 220, 270 cm
de ancho y 38,8 cm de profundidad. Múltiplos en altura de 32 y 48 cm.



Z796 SCHEMA LIBERO

ELEGANTE E SEMPRE IN FORMA

Elegant and always ready. Éléphant et toujours en forme.
Elegant und stets in Form. Elegante y siempre en forma.

2796

- 1_Combi System: armadio con ante scorrevoli Dap bianche e maniglie gola in alluminio verniciate lilla
- 2_Shape: pensili in metallo verniciato bianco e lilla
- 3_G45: comodini sospesi in termostrutturato rovere visone e ardesia
- 4_Link System: libreria in melaminico ardesia e bianco
- 5_Minimal: scrittoio sospeso in termostrutturato rovere visone
- 6_Corner: letto ardesia testata imbottita bianca
- 7_Bloom: sedia con scocca bianca

- 1_Combi System: wardrobe with white sliding doors Dap and aluminium grip profile handles with lilac varnish
- 2_Shape: metal wall units with white and lilac varnish
- 3_G45: wall night stands in thermo structured mink oak NT and slate
- 4_Link System: bookcase in melamine slate and white
- 5_Minimal: suspended writing desk in thermo structured mink oak
- 6_Corner: bed in slide with padded headboard in white
- 7_Bloom: chair with a white structure

- 1_Combi System: armoire avec portes coulissantes Dap blanches et poignées gorge en aluminium vernies mauve
- 2_Shape: éléments hauts en métal verni blanc et mauve
- 3_G45: tables de nuit suspendues en thermostructuré chêne vison et ardoise
- 4_Link System: bibliothèque en mélaminé ardoise et blanc
- 5_Minimal: bureau suspendu en thermostructuré chêne vison
- 6_Corner: lit ardoise avec tête rembourré in blanc
- 7_Bloom: chaise avec coque en polyéthylène blanche

- 1_Combi System: Schiebetürenschrank Dap in Weiß mit Griff Gola aus Aluminium in Lack Lila
- 2_Shape: Hängeschränke aus Metall in Lack Weiß und Lila
- 3_G45: hängende Nachttische thermostrukturierter Oberfläche in Eiche Neuz und Schiefer
- 4_Link System: Bücherregal aus Melamin in Schiefer und Weiß
- 5_Minimal: hangender Schreibtisch mit thermostrukturierter Oberfläche in Eiche Neuz
- 6_Corner: Bett in Schiefer, Kopfteil gepolstert in Weiß
- 7_Bloom: Stuhl mit Sitzschale in Weiß

- 1_Combi System: armario con puertas correderas Dap blancas y tiradores con perfil rebajado de aluminio pintados lila
- 2_Shape: muebles colgantes de metal pintado blanco y lila
- 3_G45: mesitas de noche colgantes termoestructurado de roble vison y pizarra
- 4_Link System: libreria de melamina pizarra y blanco
- 5_Minimal: escritorio colgante de termoestructurado de roble vison
- 6_Corner: cama pizarra, cabecero mullido blanco
- 7_Bloom: silla con armazón blanco

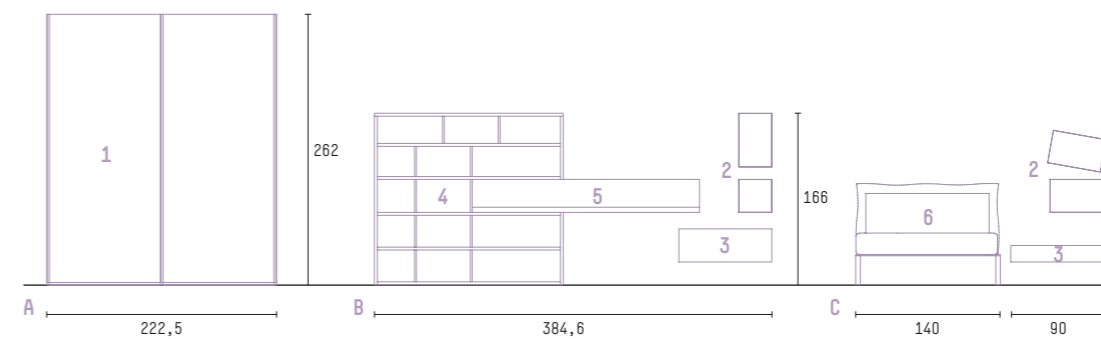
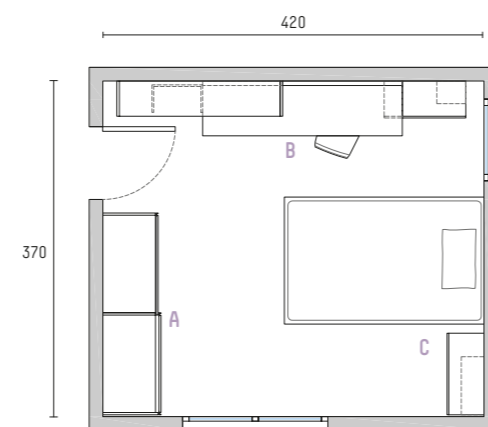



FOCUS

ZONA STUDIO ECCO GLI SPAZI PIÙ ORGANIZZATI PER LEGGERE E IMPARARE

A study area: space organised to facilitate reading and learning.
 Zone bureau, voici les espaces les plus organisés pour lire et apprendre.
 Lernzone: komplett organisierte Bereiche zum Lesen und Lernen.
 Zona de estudio he aquí los espacios más organizados para leer y aprender.





Elementi liberi o inseriti in soluzioni con librerie,
proposti in differenti forme e materiali, sempre resistenti.

Robust elements to be used free standing or included in solutions
with bookcases, proposed in different shapes and materials.

Éléments libres ou insérés dans des solutions avec bibliothèques,
proposés dans différentes formes et matériaux, toujours résistants.

Freistehende oder in Lösungen mit Bücherregalen eingefügte
Elemente, die in unterschiedlichen Formen und Materialien
angeboten werden und stets widerstandsfähig sind.

Elementos libres o aplicados en soluciones con librerías,
propuestos en distintas formas y materiales, siempre resistentes.



UN UNICO PROGETTO PER MOLTIPLICARE LO SPAZIO

MULTI SPAZIO

Voglio una cameretta per moltiplicare e organizzare lo spazio su più livelli recuperando anche i centimetri, dove sfruttare al meglio tutto l'ambiente per me e i miei amici.

A single project to multiply space. I want a place where I can multiply and organise space, gaining even centimetres so I can make the best use of my room for myself and my friends.

Un seul projet pour multiplier l'espace. Je voudrais une chambre pour multiplier et organiser l'espace sur plusieurs niveaux en récupérant même les centimètres, où exploiter au mieux l'ambiance pour moi et pour mes amis.

Ein einziges Projekt, um den Raum zu vervielfachen Ich möchte ein Kinderzimmer, um den Raum auf mehreren Ebenen zu vervielfachen und zu organisieren, indem nicht genutzte Zentimeter wiedergewonnen werden und der gesamte Raum für uns und unsere Freunde optimal genutzt wird.

Un solo proyecto para multiplicar el espacio. Deseo un dormitorio para multiplicar y organizar el espacio en más niveles utilizando también los centímetros, para disfrutar de la mejor manera todo el ambiente para mí y mis amigos.

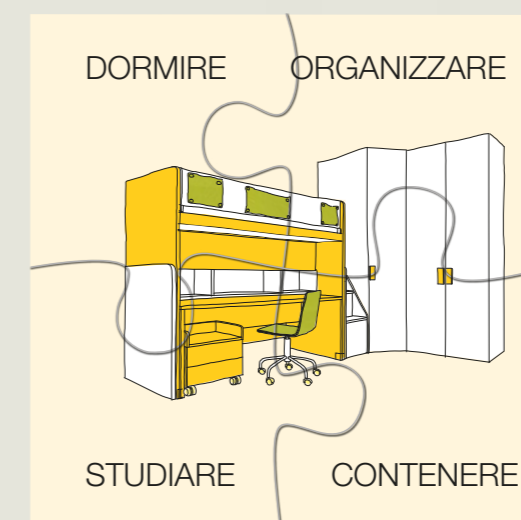



Z788 MULTISPAZIO

PROIETTATA IN UN NUOVO UNIVERSO

Projected into a new universe. Projetée dans un nouvel univers.
Mit Ausrichtung auf ein neues Universum. Proyectada en un nuevo universo.

Qui tutto è pensato per sfruttare al meglio lo spazio con efficiente funzionalità.

Here everything is designed to make maximum use of space with efficient functionality.

Ici, tout est pensé pour exploiter au mieux l'espace avec une fonctionnalité efficace.

Hier ist alles darauf ausgelegt, den Raum mit effizienter Funktionalität optimal zu nutzen.

Aquí todo es pensado para disfrutar el espacio de la mejor manera con funcionalidad eficiente.



MULTISPAZIO
Z788



FINITURE COMPOSIZIONE

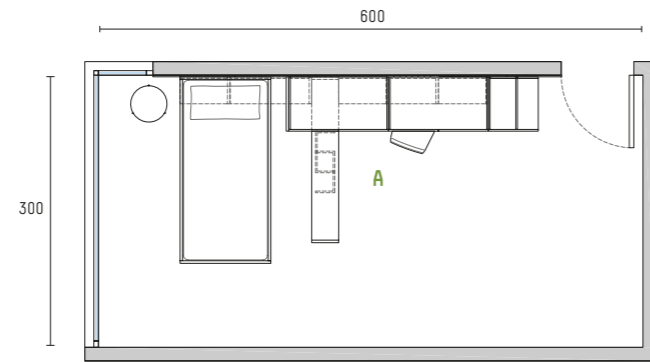

Z788

- 1_Monopoli: armadio a ponte con ante battenti in melaminico bianco
 - 2_Monopoli: colonna armadio in termostrutturato olmo sand NT e melaminico selce
 - 3_Cover: pannellatura in termostrutturato olmo sand NT
 - 4_Link System: libreria in melaminico salvia, bianco e selce
 - 5_Monopoli: mensole in melaminico salvia e selce
 - 6_Raster: letto in termostrutturato olmo sand NT e bianco
 - 7_Minimal: scrittoio in melaminico selce
 - 8_Skylab: tavolino in melaminico salvia
- Set: sedia bianca

- 1_Monopoli: white melamine hinged door overhead wardrobe
 - 2_Monopoli: thermo structured sand elm NT and flint melamine tall wardrobe unit
 - 3_Cover: thermo structured sand elm NT panelling
 - 4_Link System: sage, white and flint melamine bookcase
 - 5_Monopoli: sage and flint melamine shelves
 - 6_Raster: thermo structured sand elm NT and white bed
 - 7_Minimal: flint melamine desk
 - 8_Skylab: sage melamine occasional table
- Set: white chair

- 1_Monopoli: armoire à pont avec portes battantes en mélaminé blanc
 - 2_Monopoli: colonne armoire en thermostructuré olme sand NT et mélaminé silex
 - 3_Cover: lambrissage en thermostructuré olme sand NT
 - 4_Link System: bibliothèque en mélaminé sauge, blanc et silex
 - 5_Monopoli: tablettes en mélaminé sauge et silex
 - 6_Raster: lit en thermostructuré olme sand NT et blanc
 - 7_Minimal: bureau en mélaminé silex
 - 8_Skylab: table basse en mélaminé sauge
- Set: chaise blanche

- 1_Monopoli: Überbauschrank mit Drehtüren aus Melamin in Weiß
 - 1_Monopoli: Hochschrank mit thermostrukturierter Oberfläche in Ulme Sand NT und aus Melamin in Kiesel
 - 1_Cover: Wandpaneel mit thermostrukturierter Oberfläche in Ulme Sand NT
 - 1_Link System: Bücherregal aus Melamin in Salbei, Weiß und Kiesel
 - 1_Monopoli: Borde aus Melamin in Salbei und Kiesel
 - 1_Raster: Bett mit thermostrukturierter Oberfläche in Ulme Sand NT und Weiß
 - 1_Minimal: Schreibtisch aus Melamin in Kiesel
 - 1_Skylab: Tisch aus Melamin in Salbei
- Set: weißer Stuhl

- 1_Monopoli: armario puente con puertas batientes de melamina color blanco
 - 2_Monopoli: columna de armario de olmo sand NT termoestructurado y de melamina silex
 - 3_Cover: paneles de olmo sand NT termoestructurado
 - 4_Link System: libreria de melamina salvia, blanco y silex
 - 5_Monopoli: baldas de melamina salvia y silex
 - 6_Raster: cama de olmo sand NT termoestructurado y color blanco
 - 7_Minimal: escritorio de melamina silex
 - 8_Skylab: mesita de melamina salvia
- Set: silla blanca

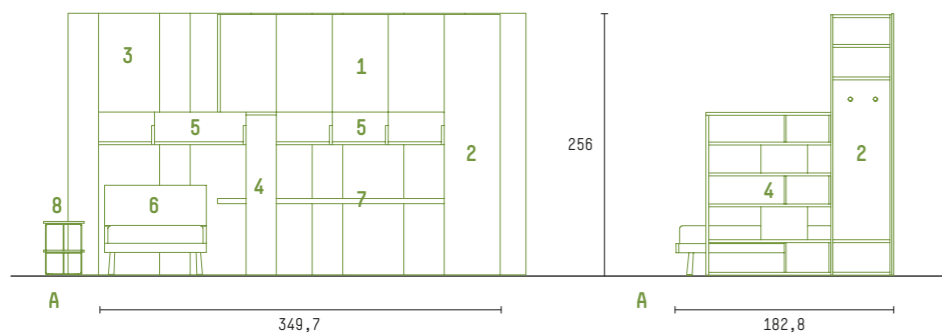



Z787 MULTISPAZIO

DINAMICA E RAFFINATA

Dynamic and refined. Dynamique et raffiné.
Dynamisch und edel. Dinámica y refinada.



MULTISPAZIO
Z787

Un progetto accogliente dove elementi di design in colore pastello creano una raffinata atmosfera.

A project that creates a warm ambience in which pastel coloured designer elements create a refined atmosphere.

Un projet accueillant où les éléments de design de couleur pastel créent une atmosphère raffinée.

Ein attraktives Projekt, bei dem pastellfarbene Designelemente eine erlesene Atmosphäre schaffen.

Un proyecto confortable en el cual los elementos de diseño de color pastel crean una atmósfera refinada.

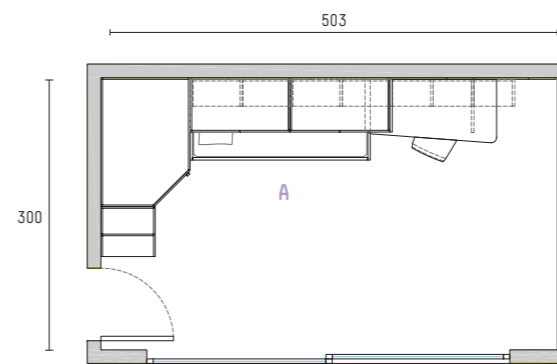

Z787

- 1.Monopoli: cabina armadio e colonna terminale in termostrutturato olmo ash NT e muschio
- 2.Monopoli: armadio a ponte ante battenti in melaminico salvia
- 3.Cover: pannellatura in termostrutturato olmo ash NT
- 4.Link System: libreria sospesa in melaminico muschio, salvia e termostrutturato olmo ash NT
- 5.Plain: letto in melaminico salvia
- 6.Scrittio: piano sagomato in termostrutturato olmo ash NT
- Bloom: sedia con scocca selce e cuscino imbottito

- 1.Monopoli: thermo structured ash elm NT and moss walk-in wardrobe and end tall unit
- 2.Monopoli: sage melamine overhead wardrobe with hinged doors
- 3.Cover: thermo structured ash elm NT panelling
- 4.Link System: moss, sage and thermo structured ash elm NT melamine hanging bookcase
- 5.Plain: sage melamine bed
- 6.Desk: thermo structured ash elm NT shaped top
- Bloom: chair with a flint structure and a padded cushion

- 1.Monopoli: cabine armoire et colonne de terminaison en thermostructuré olme ash NT et mousse
- 2.Monopoli: armoire à pont portes battantes en mélaminé sauge
- 3.Cover: lambrissage en thermostructuré olme ash NT
- 4.Link System: bibliothèque suspendue en mélaminé mousse, sauge et thermostructuré olme ash NT
- 5.Plain: lit en mélaminé sauge
- 6.Bureau: plateau façonné en thermostructuré olme ash NT
- Bloom: chaise avec coque en polyéthylène silex et coussin rembourré

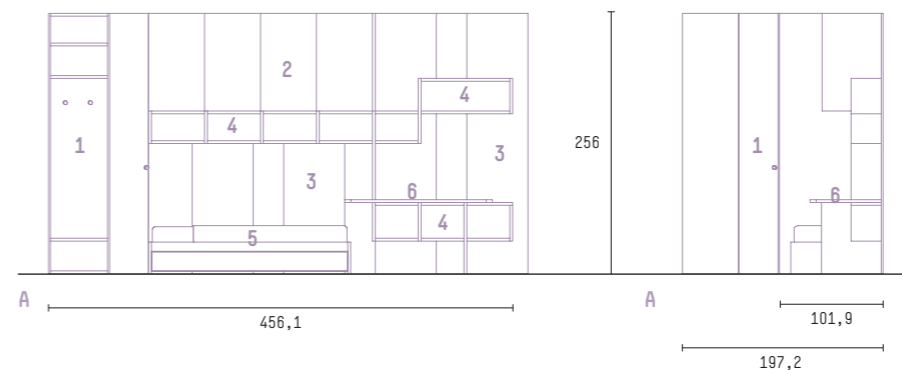

FINITURE COMPOSIZIONE





FOCUS

L'ACCOGLIENTE ATMOSFERA DELLA PANNELLATURA COVER

È facile rendere ogni spazio il più accogliente, emozionante e colorato possibile con la fantastica pannellatura Cover.

It's easy to make rooms as cosy, exciting and colourful as possible with the fantastic, Cover panelling.

Il est facile de rendre chaque espace le plus accueillant, le plus chaleureux et le plus coloré possible avec le fantastique lambrisage Cover.

Dem phantastischen Wandpaneel Cover lässt sich jeder Raum so einladend, spannend und farbig wie möglich gestalten.

Es fácil volver cualquier espacio lo más acogedor, emocionante y coloreado posible con los fantásticos paneles Cover.

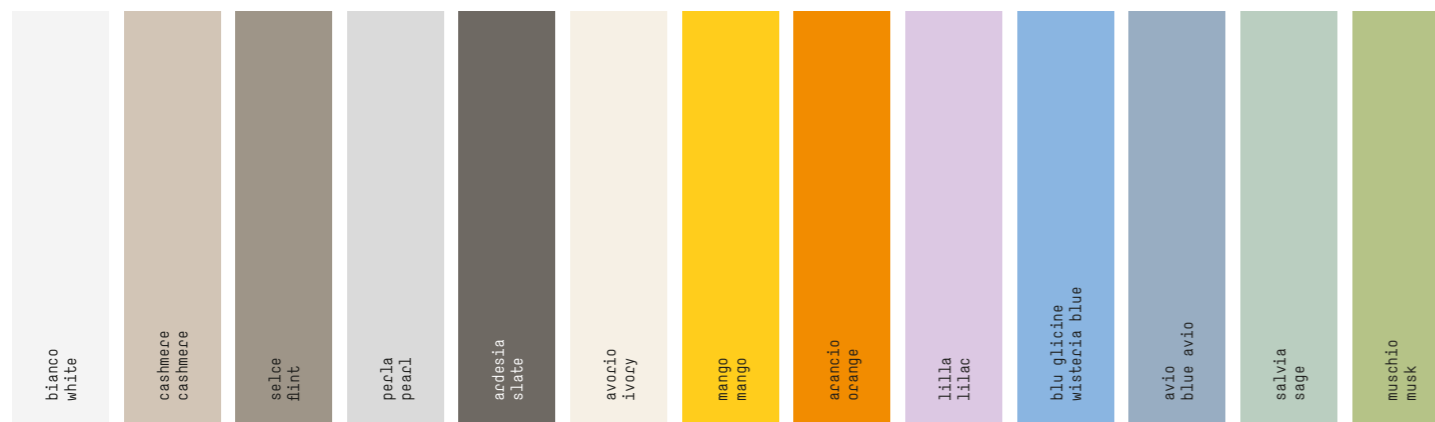



Z478 MULTISPAZIO

ECLETTICA E SOGNANTE

Eclectic and dreamy. Éclectique et chargé de rêve.
Eklektisch und verträumt. Ecléptica y de ensueño.



FINITURE COMPOSIZIONE

Z478

1. Monopoli: cabina armadio in termostrutturato olmo sand NT con maniglia Shanghai mango
2. Monopoli: armadio a ponte con ante battenti e colonna di sostegno a giorno bianco e pannellatura sotto ponte mango
3. Sandwich Line: letto in termostrutturato olmo sand NT con cassetti inferiori mango
4. Tablet: scrittoio con piano in melaminico bianco, gambe in metallo verniciate bianche e schienale con mensola porta oggetti sotto piano completamente mango, accessori in metallo, da aggancio, verniciati bianco
5. Domino: libreria bianca, mango e termostrutturato olmo sand NT

Well: sedia bianca

1. Monopoli: walk-in wardrobe in thermo structured elm sand NT with Shanghai handle in colour mango
2. Monopoli: bridge wardrobe with hinged doors and open-shelved supporting tall unit, all-white, mango panels under the bridge
3. Sandwich Line: bed elm sand NT with lower mango drawers
4. Tablet: writing desk with white melamine top, legs in white varnished metal and back with shelf under all-mango top, hook-in accessories in white varnished metal
5. Domino: bookcase in white, mango and thermo structured elm sand NT

Well: chair in white

1. Monopoli: cabine armoire en thermostructuré olme sand NT avec poignée Shanghai mangue
2. Monopoli: armoire pont avec portes battantes et colonne de soutien ouverte, le tout en blanc panneaux sous pont mangue
3. Sandwich Line: lit olme sand NT avec tiroirs mangue inférieurs
4. Tablet: bureau avec plateau en mélaminé blanc, piètements en métal vernis blancs et dos avec tablette porte-objets sous plan complètement mangue, accessoires en métal, à accrocher, vernis blanc
5. Domino: bibliothèque blanche, mangue et thermostructuré olme sand NT

Well: chaise en blanc

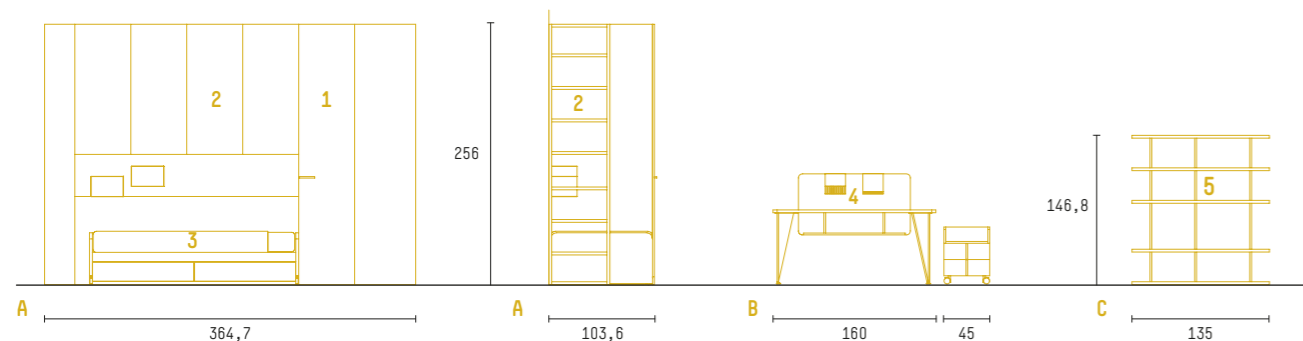

MULTISPAZIO Z478



1. Monopoli: begehbarer Schrank mit thermostrukturierter Oberfläche in Ulme Sand NT mit Griff Shanghai in Mango
2. Monopoli: Überbauschränk mit Drehtüren und offenem Hochschrank zur Abstützung ganz in Weiß Verkleidung unter dem Überbau in Mango
3. Sandwich Line: Bett in Ulme Sand NT mit unteren Schubkästen in Mango
4. Tablet: Schreibtisch mit Platte aus Melamin in Weiß, Beine aus Metall in Lack Weiß und Rückwand mit Ablageböden unter der Platte ganz in Mango, Zubehör aus Metall zum Einhängen in Lack Weiß
5. Domino: Bücherregal in Weiß, Mango und thermostrukturierter Oberfläche in Ulme Sand NT

Well: Stuhl in Weiß

1. Monopoli: armario vestidor de termoestructurado de Olmo Sand NT con tirador Shanghai mango
2. Monopoli: armario puente con puertas batientes y columna de soporte abierta totalmente blancos. Serie de paneles debajo del puente color mango
3. Sandwich Line: cama de olmo sand NT con cajones mango inferiores
4. Tablet: escritorio con sobre melaminico blanco, patas de metal pintadas blancasy trasera con balda portaobjetos debajo del sobre totalmente color mango, accesorios de metal, de enganche, pintados blanco
5. Domino: libreria blanca, mango y termoestructurado de Olmo Sand NT

Well: silla de blanco

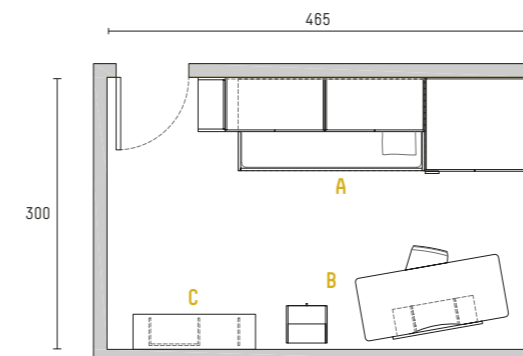



Z799 MULTISPAZIO

PRONTA AL CAMBIAMENTO

Ready for change. Prête au changement.
Zur Veränderung bereit. Lista para la transformación.

Scopri i contenuti extra con l'app Gruppo Eucomobil. Check out the extra content with Gruppo Eucomobil app.



FINITURE COMPOSIZIONE

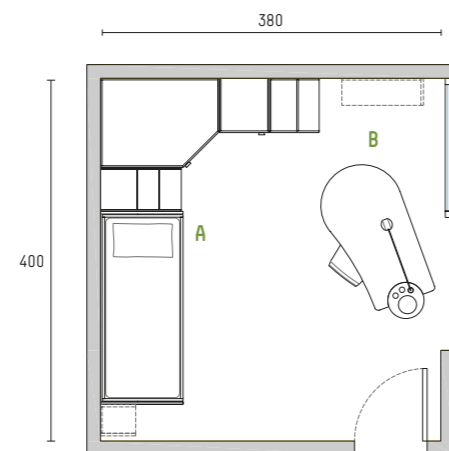

Z799

- 1.Monopoli: cabina armadio ante battenti e colonna terminale in termostrutturato olmo ash NT e muschio
- 2.Slide: letto a castello muschio e salvia pedana muschio e letto inferiore Sandwich
- 3.Link System: libreria sospesa in termostrutturato olmo ash NT e muschio
- 4.Monopoli: mensole muschio e salvia
- 5.Boog: scrittoio piano salvia e cilindro bianco Strato: sedia imbottita

- 1.Monopoli: thermo structured ash elm NT and musk walk-in wardrobe with hinged doors and end tall unit
- 2.Slide: bunk beds in musk and sage with musk platform and lower bed Sandwich in Slide
- 3.Link System: wall bookcase in thermo structured elm ash NT and musk
- 4.Monopoli: musk and sage shelves
- 5.Boog: writing desk with sage top and white cylinder Strato: padded chair

- 1.Monopoli: cabine armoire portes battantes et colonne de terminaison en thermostructuré orme ash NT et musc
- 2.Slide: lit superposé sauge et musc structure musc et lit inférieur Sandwich
- 3.Link System: bibliothèque suspendue en thermostructuré orme ash NT et musc
- 4.Monopoli: tablettes musc et sauge
- 5.Boog: bureau plateau sauge et cylindre blanc Strato: chaise cemboucrée

- 1.Monopoli: begehbare Schrank mit Drehtüren und Abschlusshochschrank mit thermostrukturierter Oberfläche in Ulme Ash NT und Moss
- 2.Slide: Etagenbett in Salbei und Moss, Podest in Moss und unteres Bett Sandwich
- 3.Link System: hängendes Bücherregal mit thermostrukturierter Oberfläche in Ulme Ash NT und Moss
- 4.Monopoli: Borde in Moss und Salbei
- 5.Boog: Schreibtisch mit Platte in Salbei und Zylinder in Weiß Strato: Stuhl gepolstertes

- 1.Monopoli: cabina vestidor con puertas batientes y columna terminal de olmo ash NT termoestructurado y musgo
- 2.Slide: literas color salvia y musgo, plataforma musgo y cama inferior Sandwich
- 3.Link System: libreria colgante de termoestructurado de olmo ash NT y musgo
- 4.Monopoli: baldas color musgo y salvia
- 5.Boog: escritorio con sobre color salvia y cilindro blanco Strato: silla acolchada

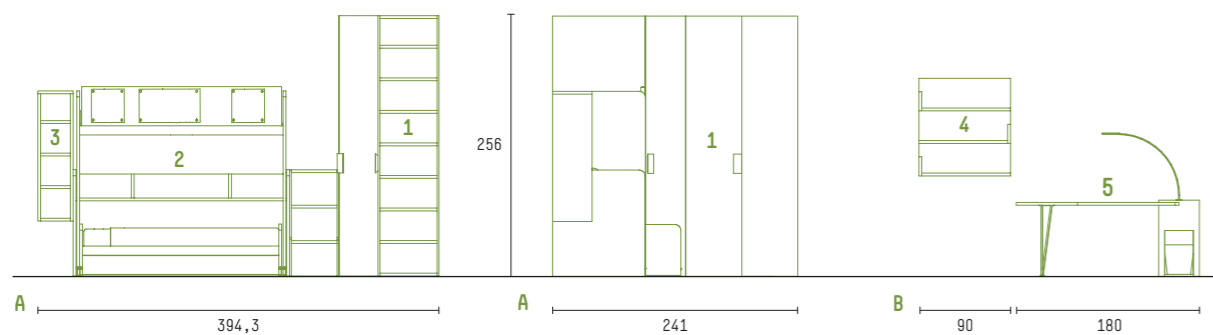



SCHEMA LIBERO
Z799



FOCUS

LETTO A CASTELLO SLIDE

Disponibile nella versione con due letti estraibili, oppure a scelta, con uno scrittoio estraibile. Completa il sistema una protezione fissa o reclinabile con sicurezza antisganciamento brevettata.

It is available with two pull-out beds, or an optional pull-out writing desk. The system features a fixed or reclining protection with a patented safety system against unfastening.

Disponibile dans la version avec deux lits extractibles, ou au choix, un bureau extractible. Pour compléter le système, une protection fixe ou inclinable avec une sécurité anti-décrochement brevetée.

Erhältlich mit zwei ausziehbaren Betten, oder auf Wunsch mit einem ausziehbaren Schreibtisch. Das System wird durch eine feste oder umklappbare Absturzicherung mit patentierter Aushaksicherung komplettiert.

Disponibles en la versión con dos camas extraíbles, o a elección, un escritorio extraíble. El sistema está equipado con una protección fija o reclinable con seguridad antidesenganche patentada.





Z672 MULTISPAZIO

DIVERTENTE E ACCOGLIENTE

Fun and snug. Amusante et accueillante.
Kurzweilig und einladend. Alegre y acogedora.

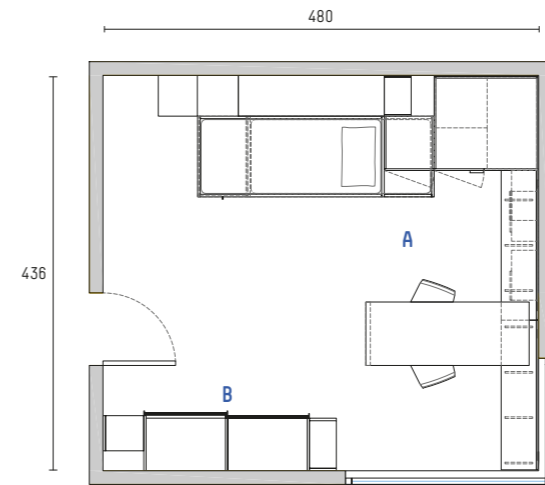

Z672

- 1.Monopoli: cabina armadio in termostrutturato olmo ash NT, elementi a gioco blu glicine
- 2.Letto a soppalco: in melaminico cashmere e sacca di protezione con tasche
- 3.Plan: letto a terra in melaminico blu glicine
- 4.Domino: libreria bassa in melaminico blu glicine e cashmere
- 5.Tex: sistema pannellatura in termostrutturato olmo ash NT
- 6.Minimal: scrittoio in melaminico cashmere
- 7.Freedom: pensili in melaminico blu glicine e cashmere
- 8.Combi System: armadio ante scorrevoli Plan XL in melaminico cashmere e maniglie blu glicine
- 9.Link System: libreria in melaminico blu glicine e termostrutturato olmo ash NT
- Well: sedie bianca

- 1.Monopoli: walk-in closet in thermo structured ash elm NT with wisteria blue open units
- 2.Loft bed: in cashmere melamine with pocketed protective cover
- 3.Plan: wisteria blue melamine floor-standing bed
- 4.Domino: low bookcase in wisteria blue and cashmere melamine
- 5.Tex: panelling system in thermo structured ash elm NT
- 6.Minimal: cashmere melamine desk
- 7.Freedom: wall units in wisteria blue and cashmere melamine
- 8.Combi System: wardrobe with Plan XL sliding doors in cashmere melamine with wisteria blue handle
- 9.Link System: bookcase in wisteria blue melamine and thermo structured ash elm NT
- Well: white chairs

- 1.Monopoli: cabine armoire en thermostructuré olme ash NT éléments ouverts bleu glycine
- 2.Lit à mezzanine: en mélaminé cashmere et sac de protection avec poches
- 3.Plan: lit au sol en mélaminé bleu glycine
- 4.Domino: bibliothèque basse en mélaminé bleu glycine et cashmere
- 5.Tex: système lambris en thermostructuré olme ash NT
- 6.Minimal: bureau en mélaminé cashmere
- 7.Freedom: éléments hauts en mélaminé bleu glycine et cashmere
- 8.Combi System: armoire portes coulissantes Plan XL en mélaminé cashmere avec poignée bleu glycine
- 9.Link System: bibliothèque en mélaminé bleu glycine et thermostructuré olme ash NT
- Well: chaises en blanc

- 1.Monopoli: begehbarer Schrank mit thermostrukturierter Oberfläche in Ulme Ash NT, offene Elemente in Blau Glyzinie
- 2.Hochbett: aus Melamin in Kaschmir und Schutzbeutel mit Taschen
- 3.Plan: Bett aus Melamin in Blau Glyzinie
- 4.Domino: flaches Bücherregal aus Melamin in Blau Glyzinie und Kaschmir
- 5.Tex: Wandpaneelsystem mit thermostrukturierter Oberfläche in Ulme Ash NT
- 6.Minimal: Schreibtisch aus Melamin in Kaschmir
- 7.Freedom: Hängeschränke aus Melamin in Blau Glyzinie und Kaschmir
- 8.Combi System: Schiebetürenschränk Plan XL aus Melamin in Kaschmir mit Griff Blau Glyzinie
- 9.Link System: Bücherregal aus Melamin in Blau Glyzinie und thermostrukturierter Oberfläche in Ulme Ash NT
- Well: Stühle in Weiß

- 1.Monopoli: cabina armario de olmo ash NT termoestructurado, elementos abiertos azul glicina
- 2.Cama de techo: de melamina color cashmere y funda de protección con bolsillos
- 3.Plan: cama de suelo de melamina azul glicina
- 4.Domino: librería baja de melamina azul glicina y color cashmere
- 5.Tex: sistema de paneles de olmo ash NT termoestructurado
- 6.Minimal: escritorio de melamina color cashmere
- 7.Freedom: muebles colgantes de melamina azul glicina y color cashmere
- 8.Combi System: armario con puertas correderas Plan XL de melamina cashmere con tirador azul glicina
- 9.Link System: librería de melamina azul glicina y olmo ash NT termoestructurado
- Well: sillas blancas

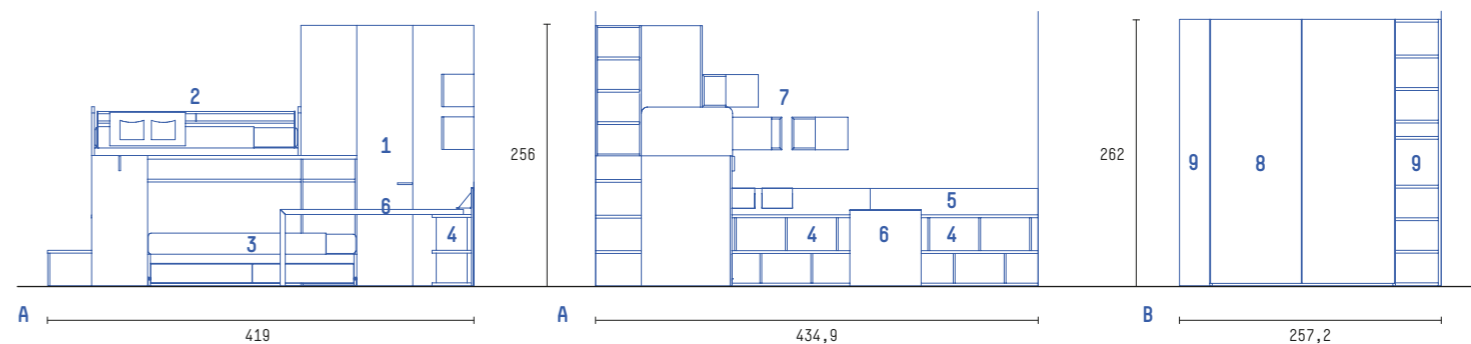

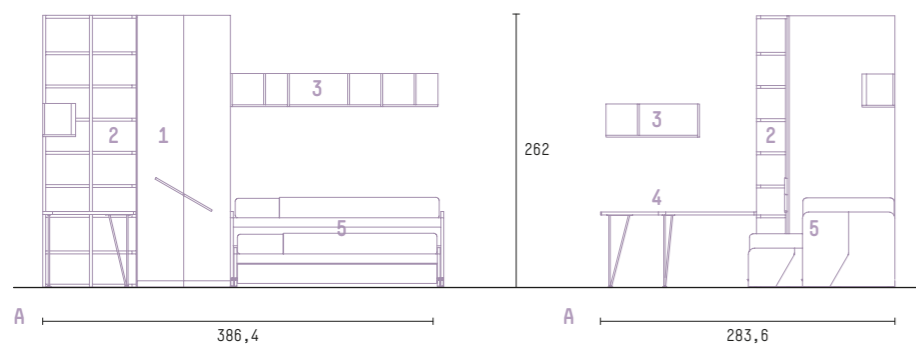

Z233

- 1_Monopoli: cabina armadio bianco, anta con maniglia shanghai lilla
 - 2_Link System: libreria in bianco e lilla
 - 3_Unoeotto: elementi pensili a giorno lilla e termostrutturato olmo sand NT
 - 4_Scrittorio sagomato termostrutturato olmo sand NT
 - 5_Club Virgola: letti a castello lilla e termostrutturato olmo sand NT
- Strato: sedia imbottita

- 1_Monopoli: white walk-in wardrobe, door with Shanghai handle in lilac
 - 2_Link System: bookcase in white and lilac
 - 3_Unoeotto: open-shelved wall units in lilac and thermo structured elm sand NT
 - 4_Writing desk in thermo structured elm sand NT
 - 5_Club Virgola: bunk beds in lilac and thermo structured elm sand NT
- Strato: padded chair

- 1_Monopoli: cabine armoire blanche, porte avec poignée shanghai mauve
 - 2_Link System: bibliothèque en blanche et mauve
 - 3_Unoeotto: éléments hauts ouverts mauve et thermostructuré olmo sand NT
 - 4_Bureau thermostructuré olmo sand NT
 - 5_Club Virgola: lits superposés mauve et thermostructuré olmo sand NT
- Strato: chaise rembourrée

- 1_Monopoli: begehbare Schrank Farbe Weiß, Tür mit Griff Shanghai Lila
 - 2_Link System: Bücherregal in Weiß und Lila
 - 3_Unoeotto: offene Hängeschränkelemente Farbe Lila und thermostrukturierter Oberfläche in Ulme Sand NT
 - 4_Schreibtisch in thermostrukturierter Oberfläche in Ulme Sand NT
 - 5_Club Virgola: Etagenbetten Farbe Lila und thermostrukturierter Oberfläche in Ulme Sand NT
- Strato: Stuhl gepolstertes

- 1_Monopoli: armario vestidor blanco, puerta con tirador shanghai lila
 - 2_Link System: libreria blanco y lila
 - 3_Unoeotto: elementos colgantes abiertos lila y termoestructurado de Olmo Sand NT
 - 4_Escritorio termoestructurado de Olmo Sand NT
 - 5_Club Virgola: literas lila y termoestructurado de Olmo Sand NT
- Strato: silla acolchado

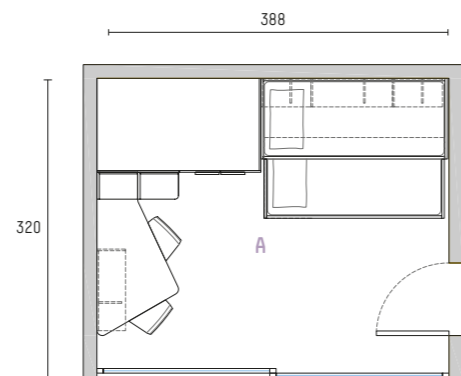

Z767 MULTISPAZIO

BRIOSAE SCATTANTE

Lively and cheerful. Enjouée et dynamique.
Überschwänglich und lebhaft. Vivaz e agil.

102

103

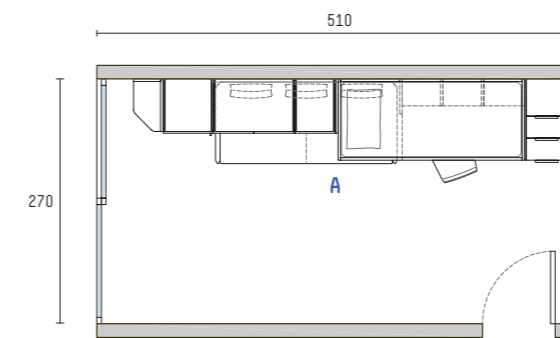

Z767

- 1_Monopoli: armadio ponte in termostrutturato olmo ash NT e avio
 - 2_Castello di Gel e Benefit: letto a castello colore avio, salvia e termostrutturato olmo ash NT
 - 3_Freebox: pensili metallo laccato salvia
 - 4_Flexy: divano letto tessuto
- Strato: sedia imbottita

- 1_Monopoli: wardrobe with bridge in thermo structured elm ash NT and blue avio
 - 2_Castello di Gel e Benefit: bunk beds in coloureden blue avio, sage and thermo structured elm ash NT
 - 3_Freebox: wall units in sage lacquered metal
 - 4_Flexy: sofa-bed in fabric
- Strato: padded chair

- 1_Monopoli: Monopoli: armoire pont thermostructuré orme ash NT et bleu avio
 - 2_Castello di Gel e Benefit: lit superposé couleur bleu avio, sauge et thermostructuré orme ash NT
 - 3_Freebox: éléments hauts métal laqué sauge
 - 4_Flexy: lit tissu jaune
- Strato: chaise rembourrée

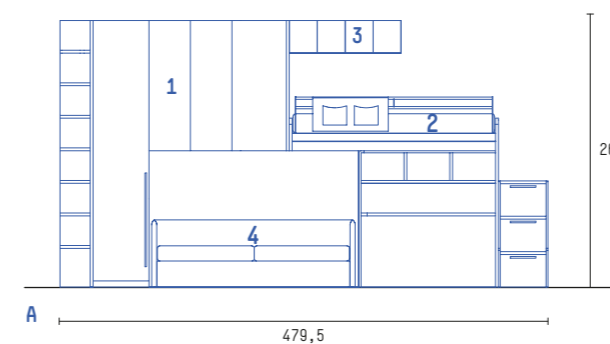

- 1_Monopoli: Überbauschrank mit thermostrukturierter Oberfläche in Ulme Ash NT und Avioblau
 - 2_Castello di Gel e Benefit: Etagenbett Farbe Avioblau, Salbei und thermostrukturierter Oberfläche in Ulme Ash NT
 - 3_Freebox: Hängeschränke aus Metall in Lack Salbei
 - 4_Flexy: Schlafsofa aus Stoff
- Strato: Stuhl gepolstertes
- 1_Monopoli: armario puente de termoestructurado de olmo ash NT y azul avio
 - 2_Castello di Gel e Benefit: literas color azul avio, salvia y de termoestructurado de olmo ash NT
 - 3_Freebox: muebles colgantes de metal lacado salvia
 - 4_Flexy: sofá cama de tejido
- Strato: silla acolchado





ZO20 MULTISPAZIO

EVOLUTA E TRASFORMISTA

Advanced and ever-changing. Évolué et changeante.
Fortschrittlich und wandelbar. Progresista y transformista.

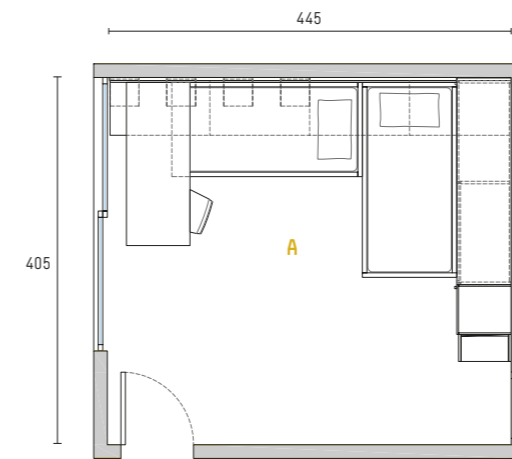

Z020

- 1.Monopoli: armadio ponte ante scorrevoli colore cashmere e libreria con schienale bianco
- 2.Oh!razio Più: boiserie colore mango e melaminico termostrutturato rovere bianco a poro aperto
- 3.Minimal: letti scorrevoli in termostrutturato rovere bianco a poro aperto
- 4.Minimal: scrittoio scorrevole in termostrutturato rovere bianco a poro aperto
- 5.Freebox: pensili metallo laccato mango e cashmere
- Strato: sedia imbottita

- 1.Monopoli: wardrobe with bridge and sliding doors in colour cashmere, bookcase with white back
- 2.Oh!razio Più: boiserie in colour mango and melamine thermo structured open pore white oak
- 3.Minimal: sliding beds in thermo structured open pore white oak
- 4.Minimal: sliding writing desk in thermo structured open pore white oak
- 5.Freebox: wall unit in metal, lacquered mango and cashmere
- Strato: padded chair

- 1.Monopoli: armoire pont portes coulissantes couleur cashmere et bibliothèque avec dos blanc
- 2.Oh!razio Più: boiserie couleur mangue et mélaminé thermostructuré chêne rouvre blanc à pore ouvert
- 3.Minimal: lits coulissants thermostructuré chêne rouvre blanc à pore ouvert
- 4.Minimal: bureau coulissant thermostructuré chêne rouvre blanc à pore ouvert
- 5.Freebox: éléments hauts métal laqué mangue et cashmere
- Strato: chaise rembourrée

- 1.Monopoli: Überbauschrank mit Schiebetüren Farbe Kaschmir und Bücherregal mit Rückwand in Weiß
- 2.Oh!razio Più: Wandpaneel Farbe Mango und aus Melamin mit thermostrukturierter Oberfläche in Eiche Weiß offenporig
- 3.Minimal: verschiebbares Bett mit thermostrukturierter in Eiche Weiß offenporig
- 4.Minimal: verschiebbares Schreibtisch mit thermostrukturierter in Eiche Weiß offenporig
- 5.Freebox: Hängeschrank aus Metall in Lack Mango und Kaschmir
- Strato: Stuhl gepolstertes

- 1.Monopoli: armario puente con puertas correderas color cashmere y libreria con trasera blanca
- 2.Oh!razio Più: boiserie color mango y de melaminico termoestructurado de roble blanco a poro abierto
- 3.Minimal: camas termoestructurado de roble blanco a poro abierto
- 4.Minimal: escritorios corredero de roble blanco a poro abierto
- 5.Freebox: muebles colgantes de metal lacado mango y cashmere
- Strato: silla acolchado

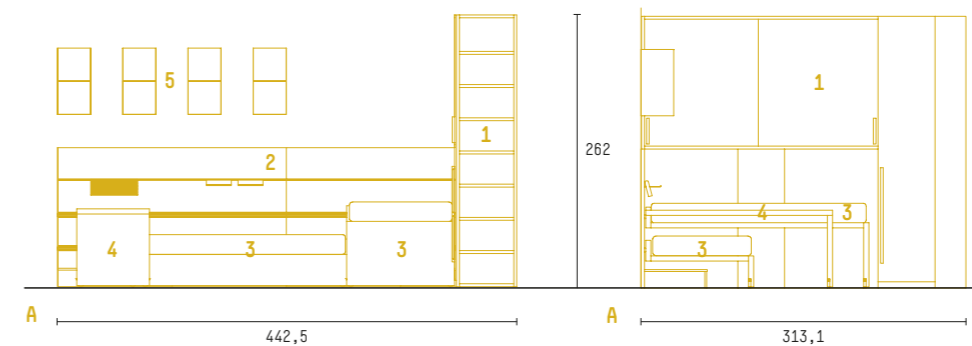

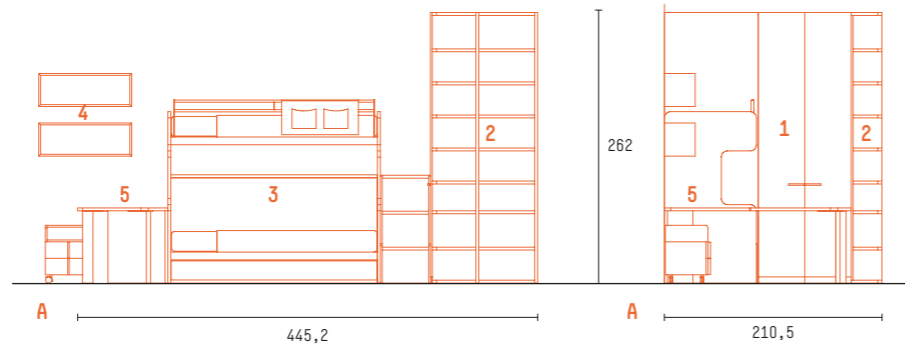

2768

- 1.Monopoli: cabina armadio termostrutturato rovere bianco poro aperto, con maniglia Shanghai arancio
 - 2.Link System: libreria termostrutturato rovere bianco poro aperto e arancio
 - 3.Castello di Gel: letti a castello termostrutturato rovere bianco a poro aperto e cashmere
 - 4.G45: pensili bianco, cashmere e arancio
 - 5.scrittioio sagomato cashmere, cassettoniera cashmere e maniglie arancio
- Poli: sedia con cuscino e schienale imbottiti

- 1.Monopoli: walk-in wardrobe in thermo structured open pore white oak, Shanghai handle in orange
 - 2.Link System: bookcase in thermo structured open pore white oak and orange
 - 3.Castello di Gel: bunk beds in thermo structured open pore white oak and cashmere
 - 4.G45: white, cashmere and orange wall units
 - 5.shaped writing desk in cashmere, chest of drawers in cashmere and orange handles
- Poli: chair with upholstered cushion and backrest

- 1.Monopoli: cabine armoire thermostructuré chêne rouvre blanc pore ouvert, ave poignée Shanghai orange
 - 2.Link System: bibliothèque thermostructuré chêne rouvre blanc pore ouvert et orange
 - 3.Castello di Gel: lits superposés thermostructuré chêne rouvre blanc à pore ouvert et cashmere
 - 4.G45: éléments hauts blanc, cashmere et orange
 - 5.bureau façonné cashmere, caisson cashmere et poignées orange
- Poli: chaise avec coussin et dossier rembourrés

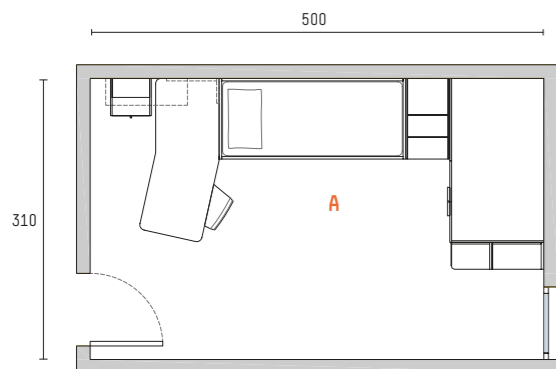

- 1.Monopoli: begebarer Schrank mit thermostrukturierter Oberfläche in Eiche Weiß offenporig, mit Griff Shanghai in Orange
 - 2.Link System: Bücherregal mit thermostrukturierter Oberfläche in Eiche Weiß offenporig und Orange
 - 3.Castello di Gel: Etagenbetten mit thermostrukturierter Oberfläche in Eiche Weiß offenporig und Farbe Kaschmir
 - 4.G45: Hängeschränke Farbe Weiß, Kaschmir und Orange
 - 5.geformter Schreibtisch in Kaschmir, Schubkastenelement in Kaschmir und Griffe in Orange
- Poli: Stuhl mit Kissen und gepolsterter Rückenlehne

- 1.Monopoli: armario vestidor de termoestructurado de roble blanco a poro abierto, con tirador Shanghai naranja
 - 2.Link System: libreria de termoestructurado de roble blanco a poro abierto y naranja
 - 3.Castello di Gel: literas de termoestructurado de roble blanco a poro abierto y cashmere
 - 4.G45: muebles colgantes blanco, cashmere y naranja
 - 4.escriptorio perfilado cashmere, cajonera cashmere y tiradores naranja
- Poli: silla con cojín y respaldo mullidos





SCHEMA LIBERO
Z768



.. 131 / 98.3 cm



.. 115 / 103.6 cm



.. 180.8 / 103.6 cm

FOCUS

SOLUZIONI ANGOLARI E LINEARI CABINA ARMADIO PERSONALIZZABILE

Corner and linear solutions for customisable walk-in wardrobes.
Solutions d'angle et linéaires cabine armoire personnalisable.
Abgewinkelte und gerade Lösungen mit individuell gestaltbarem begehbarem Schrank.
Soluciones angulares y lineales con armario vestidor personalizable.



.. 127.3 / 94.7 cm



.. 111.4 / 100 cm



.. 177.2 / 100 cm

114

115



ANTA SCORREVOLE PLAN XL



ANTA BATTENTE FOLD

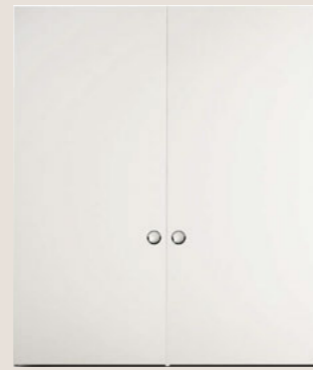

ANTA COMPLANARE RIME 22

FOCUS

ARMADIO COMBI SYSTEM ANTA BATTENTE, SCORREVOLE, COMPLANARE E A GIORNO

Armadio con struttura sp.25 mm, versione a giorno o ante con bordo raggio 1 mm sp.18 mm o 22 mm. 5 tipologie di ante battente, 4 di ante scorrevole e 3 di ante coplanare.

Wardrobe with structure th.25 mm, open version or doors with edge radius 1 mm, th.18 mm or 22 mm, 5 types of hinged door, 4 types of sliding door and 3 types of coplanar door.

Armoire avec structure ép.25 mm, version ouverte ou portes avec bord rayon 1 mm ép. 18 mm ou 22 mm. 5 typologies de porte battante, 4 typologies de porte coulissante et 3 typologies de porte coplanaire.

Schrank mit Korpus St.25 mm, Offen oder Türen mit Kante Radius 1 mm St.18 mm oder 22 mm. 5 Drehtürmodelle, 4 Schiebetürmodelle, 3 Flächenbündige Türen.

Armario con estructura esp.25 mm, version abierta o puertas con borde rayo 1 mm esp.18 mm o 22 mm de esp. 5 tipos de puerta batiente, 4 tipos de puerta corredera y 3 tipos de puerta coplanare.



STRUTTURE E ATTREZZATURE INTERNE





ANTA BICOLOR

FOCUS MONOPOLI ARMADIO ANTA BATTENTE

Tantissimi modi di combinare ante, cassetti, colori e finiture. Armadio anta battente con struttura sp.18 mm. Numerose soluzioni modulari e 4 tipologie di ante.

Endless ways to combine doors, drawers, colours and finishes. Wardrobe with hinged door, 18 mm thick structure. Various modular solutions and 4 types of door.

De nombreuses façons de combiner portes, tiroirs, couleurs et finitions. Armoire Porte battante avec structure ép.18 mm. De nombreuses solutions modulaires et 4 typologies de portes.

Zahlreiche Arten, um Türen, Schubkästen, Farben und Ausführungen miteinander zu kombinieren. Drehtürenschränk mit Korpus St.18 mm. Zahlreiche modulare Lösungen und 4 Türmodelle.

Muchísimos modos de combinar puertas, cajones, colores y acabados. Armario con puerta batiente con estructura de 18 mm de esp. Numerosas soluciones modulares y 4 tipos de puertas.



STRUTTURA COMPLETA IN MELAMINICO



FIANCHI, RIPIANI, CIELO E FONDO "INTERNO-ESTERNO" IN MELAMINICO



CREA IL TUO SPAZIO E PERSONALIZZALO CON FANTASIA

IDENTITY CARD

Create your own space and use your imagination to make it personal. Créez votre espace et personnalisez-le avec fantaisie.
Schaffen sie ihren raum und gestalten sie ihn phantasievoll nach ihren wünschen. Crea tu espacio y personalizalo con fantasia.

COLORI STRUTTURA CARCASE COLOURS



*poro aperto
open pore

**finitura materica
textured finish

Finiture e materiali ecosostenibili, una straordinaria ricerca di colori e materiali di alta qualità, dalla facile pulizia e dalle eccezionali doti di resistenza e calda matericità, realizzati con tecnologie d'avanguardia, combinabili con tessuti 100% cotone, con tessuti fantasia, con ecopelli ignifughe e con tessuti teflon.

COLORI, FINITURE, TESSUTI E MATERIALI DI ALTA QUALITÀ

MATERIALI E COLORI

PER I COLORI, I MATERIALI E GLI ASPETTI TECNICI, FARE RIFERIMENTO AI LISTINI PREZZI E RELATIVI AGGIORNAMENTI.

COLORI DI GAMMA RANGE COLOURS

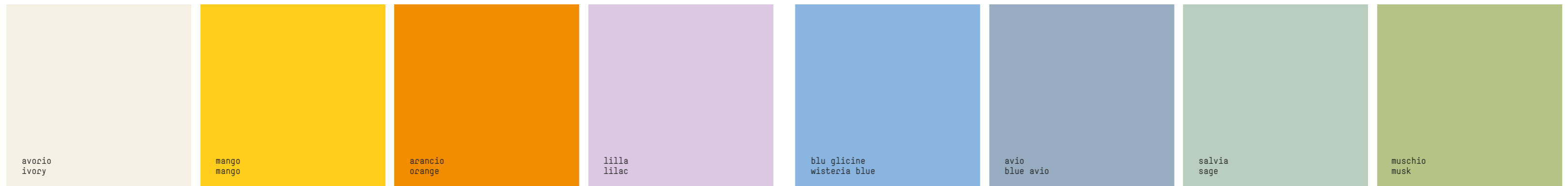

Finiture disponibili solo per schiene librerie Link System ad eccezione per H.288/294
Finishes available only for back panels and bookcases Link System except for H.288/294



VETRI GLASSES



High quality colours, finishes, fabrics and materials. Eco-friendly finishes and materials, a unique research on high quality colours and materials, easy to clean, appealing and highly resistant, produced with state-of-the-art technologies, a perfect match with 100% cotton fabrics, patterned fabrics, flame-resistant eco-leather and teflon fabrics.

Couleurs, finitions, tissus et matériaux de haute qualité. Finitions et matériaux écosoutenables, une recherche extraordinaire de couleurs et de matériaux de haute qualité, faciles à nettoyer et aux excellentes qualités de résistance et de matières chaudes, réalisés avec des technologies d'avant-garde, modulables avec des tissus 100% coton, avec des tissus fantaisie, avec des écocuirs ignifuges et avec des tissus téflon.

Farben, Ausführungen, Hochqualitative Stoffe und Materialien. Umweltverträgliche Ausführungen und Materialien, große Farbvielfalt und hochqualitative Materialien, die leicht zu reinigen sind und sich durch ausgezeichnete Festigkeit sowie warme Materialoptik auszeichnen. Sie sind mit hochmodernen Technologien hergestellt und können mit Stoffen aus 100% Baumwolle, mit Phantasie-mustern, mit feuerfestem Kunstleder und mit Teflonstoffen kombiniert werden.

Colores, acabados, tejidos y materiales de alta calidad. Acabados y materiales ecosostenibles, una búsqueda extraordinaria de colores y materiales de alta calidad, fáciles de limpiar y de excelentes características de resistencia y de cálido aspecto matérico, realizados con tecnologías de vanguardia, combinables con tejidos 100% algodón, con tejidos de fantasía, con ecopielles ignífugas y con tejidos de teflón.

METALLI METALS



TESSUTI FABRICS FOG



TEFLON



FLO

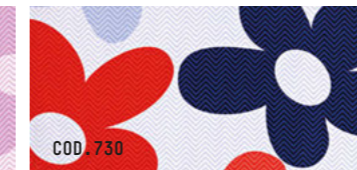
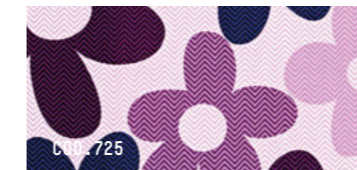

RAY

ICEBERG



ECOPELLE ECO-LEATHER MOOD



PERSONALIZZA CON
FANTASIA LA CAMERETTA
15 FORME DI MANIGLIE,
4 TAGLIE, 21 COLORI,
PIÙ APERTURA PUSH&PULL

OLTRE 150 MANIGLIE

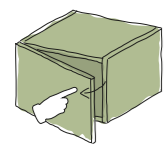

APERTURA
AUTOMATICA
PUSH&PULL

Over 150 handles. Customize your
bedroom using your imagination.
15 shapes, 4 sizes, 21 colours,
in addition to the push&pull opening.

Plus de 150 poignées. Personnalise
ta chambre avec fantaisie. 15 formes
de poignées, 4 tailles, 21 couleurs,
plus ouverture push&pull.

Über 150 Griffe. Gestalte das zimmer
mit viel phantasie individuell.
15 griffmodelle, 4 grössen,
21 farben und push-pull-öffnung.

Mas de 150 tiradores. Personaliza
el dormitorio con fantasia.
15 formas de tiradores, 4 tamaños,
21 colores, con apertura push&pull.

SMALL



MEDIUM

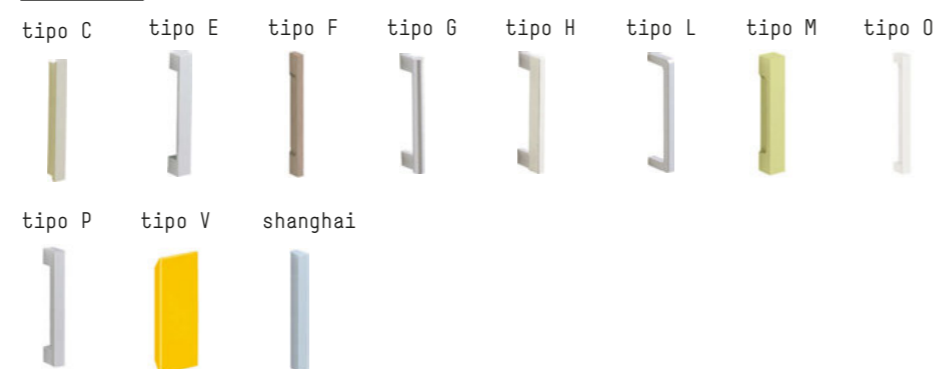

LARGE



EXTRALARGE

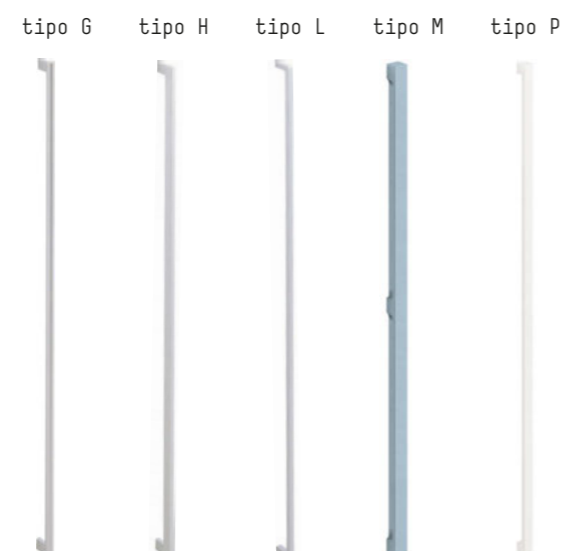

LALASS



TIPO M



SHANGHAI



SHANGHAI

PENSILI A MURO

WALL UNITS / ÉLÉMENTS HAUTS MURAUX / WANDHÄNGESCHRÄNKE / MUEBLES COLGANTES

MONOPOLI

Mensole a muro e sistema pensili a giorno, con anta battente o cassetti.
Wall shelves and open wall units, with hinged doors or drawers.
Tablettes murales et système éléments hauts ouverts, avec porte battante ou tiroirs.
Wandborde und offenes Hängeschranksystem, mit Drehtür oder Schubkästen.
Baldas empotradas y sistema de muebles colgantes abiertos, con puerta batiente o cajones.



G45

Sistema pensili a giorno o con anta unione a 45° da posizionare creativamente.
Wall unit with open shelf or door. Wall unit system with 45° joint. The elements can be placed freely.
Élément haut ouvert ou avec porte. Système éléments hauts avec union à 45° à positionner de façon créative.
Offener Hängeschrank Oder Mit Auf Gehzung Gearbeiteter Tür. Auf Gehzung gearbeitetes Hängeschranksystem, um den Raum kreativ zu gestalten.
Mueble colgante abierto o con puerta. Sistema de muebles colgantes con unión de 45° para posicionarse de modo creativo.



FREEDOM

Elementi pensili con unione a 45° e anta battente per originali abbinamenti cromatici tra interno ed esterno.
Wall units with 45° joints and hinged doors that create original colour schemes both inside and out.
Éléments hauts avec union à 45° et porte battante pour assemblages chromatiques originaux entre intérieur et extérieur.
Auf Gehzung gearbeitete Hängeelemente mit Drehtür sorgen innen und außen für originelle Farbkombinationen.
Elementos colgantes con unión de 45° y puerta batiente para combinaciones cromáticas originales entre interior y exterior.



128

UNOEOTTO

Elementi pensili a giorno sp. 1,8 cm. disponibili in termostrutturato e nei colori melaminico.
Open-shelved wall units, 1,8 cm thick, available in thermo structured and in melamine colour.
Éléments hauts ouverts ép. 1,8 cm. disponibles en thermostructuré et dans les couleurs en mélaminé.
Offene Hängeschrankelemente St. 1,8 cm erhältlich mit thermostrukturierter Oberfläche und in den Melaminfarben.
Elementos colgantes abiertos de 1,8 cm de esp. disponibles en termoestructurado y en los colores del melamínico.



SHAPE

Pensili a giorno in metallo sp. 0,2 cm. dal design minimale, disponibile in 12 colori liberamente componibili.
Open-shelved wall units in metal, 0,2 cm thick, with a minimalist design, available in 12 colours. The elements can be placed freely.
Éléments hauts ouverts en métal ép. 0,2 cm. au design minimal, disponibles dans 12 couleurs librement modulables.
Offene Hängeschränke aus Metall St. 0,2 cm. Mit minimalistischem Design, erhältlich in 12 Farben, die beliebig miteinander kombiniert werden können.
Muebles colgantes abiertos de metal de 0,2 cm de esp. de diseño minimalista, disponibles en 12 colores libremente componibles.



FREEBOX

Sistema pensili a giorno in metallo sp. 0,2 cm. in 12 colori componibili a piacere.
System with open-shelved metal wall units, 0,2 cm thick, available in 12 colours. The elements can be placed freely.
Système éléments hauts ouverts en métal ép. 0,2 cm. dans 12 couleurs modulables librement.
Offenes Hängeschranksystem aus St. 0,2 cm in 12 Farben, die beliebig miteinander kombiniert werden können.
Sistema de muebles colgantes abiertos de metal de 0,2 cm de esp. en 12 colores componibles a gusto.



129

LETTI SINGOLI E PIAZZA 1/2

SINGLE AND EXTRA WIDE SINGLE BEDS / LITS 1 PLACE ET 1 PLACE 1/2 / EINZELBETTEN UND FRANZÖSISCHE BETTEN / CAMAS INDIVIDUALES Y DE 1/2 PLAZA

Struttura in melaminico, disponibile in tutti i colori, completo di rete a doghe.
Melamine structure, available in all colours, slat base.
Structure en mélaminé, disponible dans toutes les couleurs, équipé de sommier à lattes.
Korpus aus Melamin, erhältlich in allen Farben, inklusiv Lattenrost.
Estructura de melaminico, disponible en todos los colores, con somier de tablillas.

PLAIN



...89/100/124 / 198,6/205,6 188

SANDWICH SOFT



...89/100/124 / 198,6/205,6 188

DUAL



...89/100/124 / 198,6/205,6 188

FAN



...89/100/124 / 198,6/205,6 188

SANDWICH LINE



...89/100/124 / 198,6/205,6 188

LIP



...89/100/124 / 198,6/205,6 188

LETTI SINGOLI E PIAZZA 1/2

SINGLE AND EXTRA WIDE SINGLE BEDS / LITS 1 PLACE ET 1 PLACE 1/2 / EINZELBETTEN UND FRANZÖSISCHE BETTEN / CAMAS INDIVIDUALES Y DE 1/2 PLAZA

Struttura in melaminico, disponibile in tutti i colori, completo di rete a doghe.
 Melamine structure, available in all colours, slat base.
 Structure en mélaminé, disponible dans toutes les couleurs, équipé de sommier à lattes.
 Korpus aus Melamin, erhältlich in allen Farben, inklusiv Lattenrost.
 Estructura de melaminico, disponible en todos los colores, con somier de tablillas.

WAVE



... 89/100/124 / 198,6/205,6 188

TRAP



... 89/100/124 / 198,6/205,6 188

VIRGOLA



... 89/100/124 / 198,6/205,6 188

BICOLOR



... 89/100 / 198,6/205,6 180



... 89/100 / 198,6/205,6 180



... 89/100 / 198,6/205,6 180

PIEDINI PER LETTO BICOLOR / BICOLOR FEET FOR BEDS



LETTI SINGOLI E PIAZZA 1/2

SINGLE AND EXTRA WIDE SINGLE BEDS / LITS 1 PLACE ET 1 PLACE 1/2 / EINZELBETTEN UND FRANZÖSISCHE BETTEN / CAMAS INDIVIDUALES Y DE 1/2 PLAZA

VELA



...89/100/124 / 198,6/205,6 188

ONDA



...89/100 / 198,6/205,6 191

RASTER



...89/100/124 / 198,6/205,6 188

134

Struttura in melaminico, disponibile in tutti i colori, completo di rete a doghe.
Melamine structure, available in all colours, slat base.
Structure en mélaminé, disponible dans toutes les couleurs, équipé de sommier à lattes.
Korpus aus Melamin, erhältlich in allen Farben, inklusiv Lattenrost.
Estructura de melaminico, disponible en todos los colores, con somier de tablillas.

BANDY



...89/100/124 / 198,6/205,6 188

FUNNY 1



...89/100 / 198,6/205,6 187

FUNNY 2



...89/100 / 198,6/205,6 195



135

LETTI SINGOLI E PIAZZA 1/2

SINGLE AND EXTRA WIDE SINGLE BEDS / LITS 1 PLACE ET 1 PLACE 1/2 / EINZELBETTEN UND FRANZÖSISCHE BETTEN / CAMAS INDIVIDUALES Y DE 1/2 PLAZA

Letti in melaminico con testata fantasia, struttura sagomata, completo di rete a doghe.
Melamine beds with patterned headboard, shaped structure, slat base.
Lits en mélaminé avec tête fantaisie, structure façonnée, équipé de sommier à lattes.
Bett aus Melamin, Kopfteil mit Phantasiemuster, Korpus geformt, inklusiv Lattenrost.
Camas de melamínico con cabecero de fantasía, estructura perfilada, con somier de tablillas.

AMBO



-- 112 / 218 187

AMBO



-- 112 / 218 195



-- 112 / 218 195



-- 112,2 / 211,7 180



LETTI SINGOLI E PIAZZA 1/2

SINGLE AND EXTRA WIDE SINGLE BEDS / LITS 1 PLACE ET 1 PLACE 1/2 / EINZELBETTEN UND FRANZÖSISCHE BETTEN / CAMAS INDIVIDUALES Y DE 1/2 PLAZA

Struttura in melaminico con 4 forme di testata, predisposto per estraibili, rete a doghe.
Melamine structure with 4 types of headboard, suitable for pull-out units, slat base.
Structure en mélaminé con 4 formes de tête, prédisposé pour extraction, sommier à lattes.
Korpus aus Melamin, mit 4 Kopfteilformen, vorgerüstet zum Ausziehen, Lattenrost.
Estructura de melamínico con 4 formas de cabecero, preajustada para elementos extraíbles, somier de tablillas.

PASOL



...112,5 / 205,6 170

PASOL



...150 / 205,6 182



...135/150 / 205,6 170



...150 / 205,6 182

LETTI SINGOLI E PIAZZA 1/2

SINGLE AND EXTRA WIDE SINGLE BEDS / LITS 1 PLACE ET 1 PLACE 1/2 / EINZELBETTEN UND FRANZÖSISCHE BETTEN / CAMAS INDIVIDUALES Y DE 1/2 PLAZA

BED45

fisso / fixed



100/124 / 210 187

BED45

con meccanismo di sollevamento / with lifting mechanism



100/124 / 210 187

PIEDINI PER LETTO BED45 / BED45 FEET FOR BEDS



140

Struttura in melaminico con piedini o box contenitore, disponibile in tutti i colori.
Melamine carcass with feet or storage box, available in all colours.
Structure en mélaminé avec pieds ou box de rangement, disponible dans toutes les couleurs.
Korpus aus Melamin mit Füßen oder Bettkasten, erhältlich in allen Farben.
Estructura de melamina con patas o contenedor, disponible en todos los colores.

KING BED

con meccanismo di sollevamento / with lifting mechanism



120 / 205,6 182

SANDWICH

divano / sofa



89 / 198,6 179

141

LETTI SOMMIER E ATTREZZATI

SOMMIER AND STORAGE BEDS / LITS SOMMIER ET ÉQUIPÉS / LIEGEN UND FUNKTIONELLE BETTEN / CAMAS SOMMIER Y EQUIPADAS

Struttura in melaminico, disponibile in tutti i colori.
Melamine structure, available in all colours.
Structure en mélaminé, disponible dans toutes les couleurs.
Korpus aus Melamin, erhältlich in allen Farben.
Estructura de melamínico, disponible en todos los colores.

PLAIN



... 89/100/124 / 198,6/205,6 131

VIRGOLA



... 89/100/124 / 198,6/205,6 152

SANDWICH LINE



... 89/100/124 / 198,6/205,6 152

LIP



... 89/100 / 198,6/205,6 152

SANDWICH SOFT



... 89/100/124 / 198,6/205,6 152

WAVE



... 89/100 / 198,6/205,6 152

LETTI SOMMIER E ATTREZZATI

SOMMIER AND STORAGE BEDS / LITS SOMMIER ET ÉQUIPÉS / LIEGEN UND FUNKTIONELLE BETTEN / CAMAS SOMMIER Y EQUIPADAS

Struttura in melaminico, disponibile in tutti i colori.
 Melamine structure, available in all colours.
 Structure en mélaminé, disponible dans toutes les couleurs.
 Korpus aus Melamin, erhältlich in allen Farben.
 Estructura de melaminico, disponible en todos los colores.

BICOLOR



...89/100 / 198,6/205,6 152

PASOL



...112 / 205,6 137

FUNNY



...89/100 / 198,6/205,6 131



...112 / 205,6 137

AMBO



...112 / 218 131

PIEDINI PER LETTI FUNNY E AMBO / FUNNY E AMBO FEET FOR BEDS



LETTI SOMMIER E ATTREZZATI

SOMMIER AND STORAGE BEDS / LITS SOMMIER ET ÉQUIPÉS / LIEGEN UND FUNKTIONELLE BETTEN / CAMAS SOMMIER Y EQUIPADAS

BASICO
fisso / fixed



--98 / 204 132

BASICO
con meccanismo di sollevamento / with lifting mechanism



--98 / 204 132

KING BED
con meccanismo di sollevamento / with lifting mechanism



--120 / 205,6 141

Sommier in melaminico con piedini o box contenitore, disponibile in tutti i colori.
Melamine sommier bed with feet or storage box, available in all colours.
Sommier en mélaminé avec pieds ou box de rangement, disponible dans toutes les couleurs.
Liege aus Melamin mit Füßen oder Bettkasten, erhältlich in allen Farben.
Cama Sommier de melamina con patas o contenedor, disponible en todos los colores.

BED 45
fisso / fixed



--100/124 / 206 131

BED 45
con meccanismo di sollevamento / with lifting mechanism



--100/124 / 206 131



--100/124 / 206 131

PIEDINI PER LETTO BED45 FISSO / FIXED BED45 FEET FOR BEDS



LETTI SINGOLI E PIAZZA 1/2

SINGLE AND EXTRA WIDE SINGLE BEDS / LITS 1 PLACE ET 1 PLACE 1/2 / EINZELBETTEN UND FRANZÖSISCHE BETTEN / CAMAS INDIVIDUALES Y DE 1/2 PLAZA

Struttura in melaminico sp.5 cm con testiera in melaminico, imbottita o capitonnè, rete a doghe.
 Melamine structure, 5 cm thick, melamine, padded or deep buttoned headboard, slat base.
 Structure en mélaminé ép.5 cm avec tête en mélaminé, rembourrée ou capitonné, sommier à lattes.
 Korpus aus Melamin St.5 cm mit Kopfteil aus Melamin, gepolstertem oder Capitoné, Lattenrost.
 Estructura de melaminico de 5 cm de esp, con cabecero de melaminico, acolchado o capitonè, somier de tablillas.

MINIMAL
melaminico / melamine



-- 89/104/128 / 210 130,5/88



-- 89/104 / 210 127/88



-- 89/104/128 / 210 130,5/88

MINIMAL
imbottito / padded



-- 94,4/109/133 / 213 130,5/89,5



-- 94,4/109/133 / 213 130,5/89,5



-- 94,4/109/133 / 213 130,5/89,5



LETTI SINGOLI E PIAZZA 1/2

SINGLE AND EXTRA WIDE SINGLE BEDS / LITS 1 PLACE ET 1 PLACE 1/2 / EINZELBETTEN UND FRANZÖSISCHE BETTEN / CAMAS INDIVIDUALES Y DE 1/2 PLAZA

Letto in metallo verniciato, testata imbottita rivestita in tessuto; pianale multistrato.
 Bed in varnished metal, padded headboard with fabric upholstery, plywood base.
 Lit en métal verni, tête rembourrée revêtue en tissu; plateforme multiplis.
 Bett aus lackiertem Metall, gepolstertes Kopfteil mit Stoffbezug; Liegefläche aus Schichtholz.
 Cama de metal pintado, cabeceero acolchado tapizado de tejido; plataforma de madera multicapa.

TRENDY



-- 106/130 / 207,8 185

CORNER



-- 110 / 220 195 -- 140 / 220 195

PANTÒ



-- 106/130 / 207,8 185

CORNER SOMMIER



-- 110 / 220 129 -- 140 / 220 129

PIEDINI PER LETTI TRENDY E PANTÒ / TRENDY E PANTÒ FEET FOR BEDS

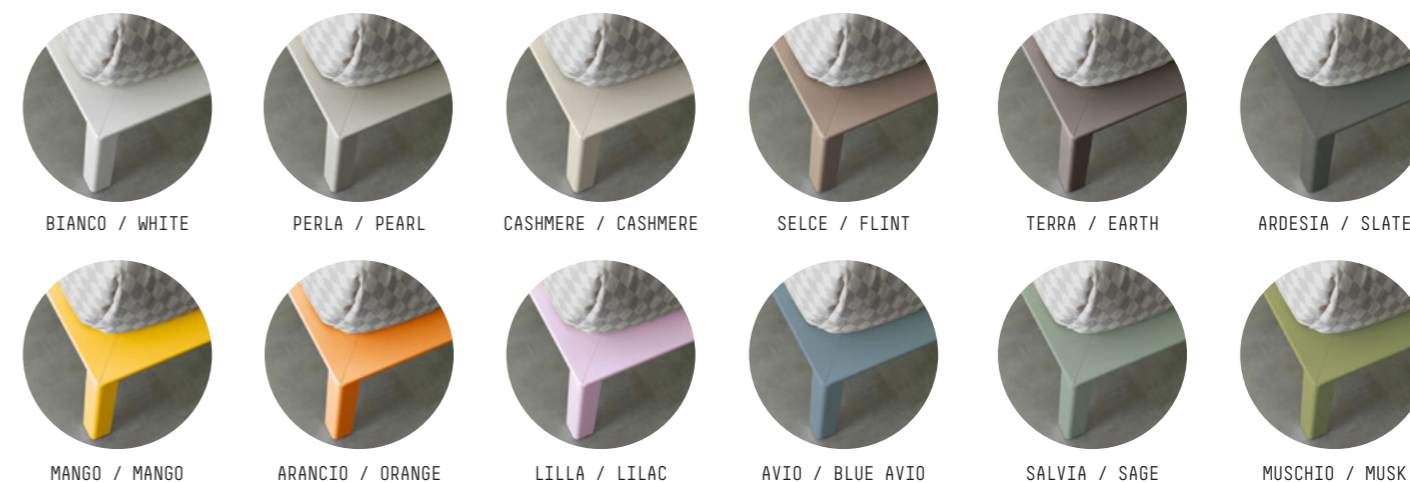

LETTI SOMMIER E ATTREZZATI

SOMMIER AND STORAGE BEDS / LITS SOMMIER ET ÉQUIPÉS / LIEGEN UND FUNKTIONELLE BETTEN / CAMAS SOMMIER Y EQUIPADAS

MINIMAL



... 89,4/104/128 / 128 130,5



... 89,4/104/128 / 128 130,5



... 89,4/104 / 210 127

152

Struttura melaminico in tutti i colori, accessoriabile con letto o cassette estraibili.
Melamine structure in all colours, suitable for pull-out bed or drawers.
Structure en mélaminé dans toutes les couleurs, accessorisable avec lit ou tiroirs extractibles.
Korpus aus Melamin in allen Farben, ausstattbar mit Bett oder ausziehbaren Schubkästen.
Estructura de melamínico en todos los colores, equipable con una cama o con cajones extraíbles.



... 89,4/104/128 / 128 130,5



... 89,4/104/128 / 128 130,5

153

LETTI SINGOLI E PIAZZA 1/2

SINGLE AND EXTRA WIDE SINGLE BEDS / LITS 1 PLACE ET 1 PLACE 1/2 / EINZELBETTEN UND FRANZÖSISCHE BETTEN / CAMAS INDIVIDUALES Y DE 1/2 PLAZA

WEB



... 102/126 / 218 186

WEB SOMMIER



... 102/126 / 208 131,5

SELÀ



... 106 / 211 170

154

Letti imbottito in tessuto sfoderabile, rete a doghe.
Padded beds in removable fabric, slat base.
Lits rembourré en tissu déhoussable, sommier à lattes.
Polsterbett mit abziehbarem Bezug, Lattenrost.
Camas acolchada de tejido desenfundable, somier de tablillas.

BULL

con meccanismo di sollevamento / with lifting mechanism



... 113/143 / 223 193



... 113/143 / 223 193

PIEDINI PER LETTI WEB E SELÀ / WEB E SELÀ FEET FOR BEDS



155

LETTI SINGOLI E PIAZZA 1/2

SINGLE AND EXTRA WIDE SINGLE BEDS / LITS 1 PLACE ET 1 PLACE 1/2 / EINZELBETTEN UND FRANZÖSISCHE BETTEN / CAMAS INDIVIDUALES Y DE 1/2 PLAZA

Struttura imbottita rivestita in tessuto, rete a doghe, vano di contenimento sotto rete.
Padded structure upholstered in fabric, slat base, storage unit under the base.
Structure rembourrée revêtue en tissu, sommier à lattes, compartiment de rangement sous sommier.
Gepolsterter Korpus mit Stoffbezug, Lattenrost, Stauraum unter dem Lattenrost.
Estructura acolchada tapizada de tejido, somier de tablillas, compartimiento contenedor debajo del somier.

FLEXY BOX

con meccanismo di sollevamento / with lifting mechanism



91/127 / 202 178

FLEXY BOX

divano letto / sofa-bed



92 / 208 172

FLEXY BOX SOMMIER

con meccanismo di sollevamento / with lifting mechanism



91/127 / 202 132



80 / 190 148

LETTI ATTREZZATI

STORAGE BEDS / LITS ÉQUIPÉS / FUNKTIONELLE BETTEN / CAMAS EQUIPADAS

CLUB SANDWICH LINE



... 89 / 205,6 172,8

CLUB SANDWICH SOFT



... 89 / 205,6 172,8

CLUB VIRGOLA



... 89 / 205,6 172,8

LETTI A CASTELLO

BUNK BEDS / LITS SUPERPOSÉS / ETAGENBETTEN / LITERAS

CASTELLO SLIDE



... 91/127,8 / 212,6 182



... 91/127,8 / 212,6 182



Scopri i contenuti extra con l'app Gruppo Eucomobil. Check out the extra content with Gruppo Eucomobil app.

LETTI A CASTELLO

BUNK BEDS / LITS SUPERPOSÉS / ETAGENBETTEN / LITERAS

CASTELLO DI GEL

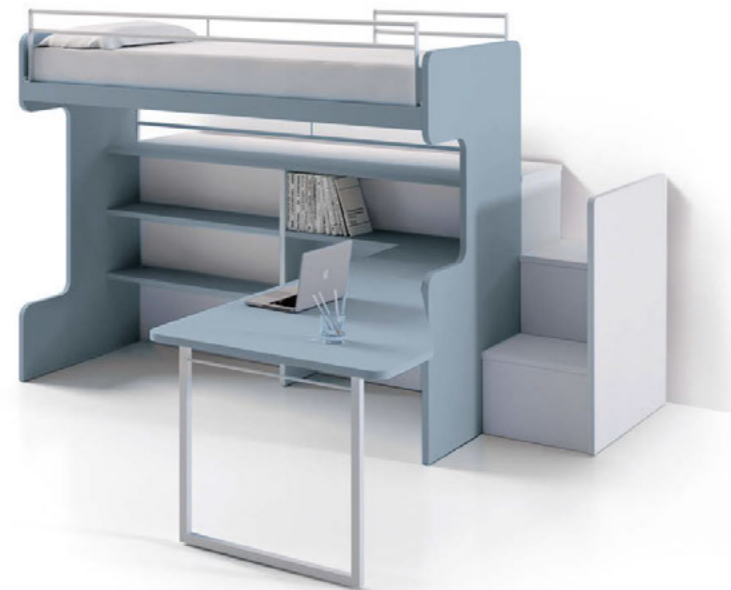

... 253,4 / 253 1166



... 253,4 / 134 1166



... 253,4 / 134 1166

160

LETTI A PARETE

UPPER BEDS / LITS SUPÉRIEUR / OBERES BETT / CAMAS SUPERIOR

BENEFIT



... 205,6 / 89 1166

CASTELLO DI GEL



... 205,6 / 89 1166

BOOKBED



... 232,5 / 100 1173

161

ELEMENTI CON LETTI A RIBALTA

ELEMENTS WITH FLAP BEDS / ELEMENTS AVEC LITS RELEVABLES / ELEMENTE MIT KLAPPBETT / ELEMENTOS CON CAMAS ABATIBLES

Comodi e pratici elementi con letti a scomparsa orizzontale o a ribalta verticale, con rete a doghe.
Convenient, practical elements with horizontal or vertical fold-away beds, with slatted base.
Éléments confortables et pratiques avec lits escamotables horizontaux ou escamotables verticaux, avec sommier à lattes.
Bequeme und praktische Elemente mit horizontalen Schrankbetten oder vertikalen Klappbetten, mit Lattenrost.
Elementos cómodo y funcionales con camas escamoteables horizontales o plegables verticales, con somier de tablillas.

ELEMENTI CON LETTI A SCOMPARSA ORIZZONTALE ELEMENTS WITH HORIZONTAL FOLD-AWAY BEDS



-- 207,3 / 29,7 194



-- 207,3 / 29,7 194



-- 207,3 / 29,7 1179



-- 207,3 / 29,7 1179

ELEMENTI CON LETTI A RIBALTA VERTICALE ELEMENTS WITH VERTICAL FOLD-AWAY BEDS



-- 90 / 40,7 1198



-- 90 / 220 1198



-- 200 / 40,7 1198



-- 200 / 220 1198

SCRITTOI

WRITING DESKS / BUREAUX / SCHREIBTISCHE / ESCRITORIOS

Superfici antigraffio, piani colorati e sagomati offrono tanto spazio ai momenti della giornata dedicati allo studio.
Scratch-resistant surfaces and colourful shaped tops create a perfect space for studying.
Des surfaces anti-rayures, des plateaux colorés et façonnés offrent beaucoup d'espace aux moments de la journée dédiés à l'étude.
Kratz feste Oberflächen und farbenfrohe Freiformplatten bieten viel Platz, wenn es Zeit zum Lernen.
Superficies antiarañazo, sobres colorados y perfilados ofrecen mucho espacio a los instantes del día dedicados al estudio.



164



165

SCRITTOI

WRITING DESKS / BUREAUX / SCHREIBTISCHE / ESCRITORIOS

TABLET



... 160/180 / 72,8 | 108,2

MINIMAL



... 135/160 / 70 | 175

UP



... 105/135/150 / 65 | 117,2

MINIMAL



... 90/110/135/165/180/220 / 60,4 | 132/48

MINIMAL / MINIMAL 45



... 135/180 / 60,4/70 | 175



STELO



... 150/180 / 90 | 172,8

SCRITTOI

WRITING DESKS / BUREAUX / SCHREIBTISCHE / ESCRITORIOS

ARCHIMEDE design Andrea Lucatello



— 130/160 / 70 171,8

SCRIBA



— 130/160 / 70 171,8

SKATE SYSTEM



— 135 / 70 175

168

GALAXY design Andrea Lucatello



— 135 / 86 172,8

LINE DESK



— 135 / 60,4/130 172,8

ROUND DESK



— 90 / 135 172,8

169

COMODINI, CASSETTIERE, TAVOLINI E POUF

NIGHT STANDS, CHESTS OF DRAWERS, SMALL TABLES AND FOOTSTOOLS / TABLES DE NUIT, CAISSONS, TABLES BASSES ET POUFS
NACHTTISCHE, SCHUBKASTENELEMENTE, TISCHE UND POUFS / MESITAS DE NOCHE, CAJONERAS, MESITAS Y PUFFS

COMODINO G45 sospeso

Posizionabile a parete il comodino è caratterizzato da unione a 45°.
Night stand with 45° joint, to be placed on wall.
Positionnable au mur la table de nuit est caractérisée par une union à 45°.
Der auf Gehung gearbeitete Nachttisch kann an der Wand positioniert werden.
Posicionable de pared, la mesita de noche está caracterizada por una unión de 45°.



... 45/55/90 / 40,7 116

CASSETTIERE con vassoio

Cassettiere melaminica con elemento vassoio, su ruote.
Melamine chests of drawers with tray, on wheels.
Caisson en mélaminé avec élément plateau, sur roulettes.
Schubkastenelemente aus Melamin mit Ablage, auf Rollen.
Cajoneras de melamínico con elemento bandeja, sobre ruedas.



... 45/55/90/110 / 41 156

COMODINO MINIMAL

Comodino con struttura sp. 5 cm proposto con uno, due o senza cassetti.
Night stand with structure 5 cm thick, available with 1, 2 or no drawers.
Table de nuit avec structure ép. 5 cm proposée avec un, deux ou sans tiroirs.
Nachttisch mit Korpus St. 5 cm, erhältlich mit einem, zwei oder ohne Schubkästen.
Mesita de noche con estructura de 5 cm de esp. propuesta con uno, dos o sin cajones.



... 51,4 / 41,2 138,6

170

COMODINO LEM

Comodino a due cassetti con sponde dotato di ruote unidirezionali.
Night stand with 2 drawers and edge, equipped with unidirectional wheels.
Table de nuit à deux tiroirs avec ridelles dotées de roulettes unidirectionnelles.
Nachttisch mit zwei Schubkästen und Seitenteilen auf Bockrollen.
Mesita de noche de dos cajones con bordes equipada con ruedas unidireccionales.



... 45 / 41,1 153,9

TAVOLINI SKYLAB

Tavolini skylab con piani colorati.
Skylab small tables with coloured top.
Tables basses skylab avec plateaux colorés.
Tische Skylab mit farbigen Platten.
Mesitas skylab con sobres colorados.



Ø50/40 122/50

POUF GEL

Pouf imbottiti con palline di polistirolo. Rivestiti in tessuto sfoderabile.
Padded footstool filled with polystyrene balls, upholstered with removable fabric.
Poufs rembourrés avec boules de polystyrène, revêtus en tissu déhoussable.
Mit Polystyrolkugeln gepolsterte Poufs, mit abziehbarem Stoffbezug.
Puffs acolchados con perlas de poliestireno, tapizados de tejido desenfundable.



Ø45 139

... 45 / 45 139

171

SEDIE

CHAIRS / CHAISES / STÜHLE / SILLAS

BIT

Base in acciaio verniciata su ruote, regolazione altezza.
Painted steel base on wheels, height regulation.
élément bas en acier verni sur roulettes, réglage hauteur.
estell aus lackiertem Stahl auf Rollen, höhenverstellbar.
Meblo bajo de acero pintado sobre ruedas, con regulación de la altura.



.. 59 / 59 175/83

ELIPSE

Scocca in plastica, base in acciaio verniciata su ruote, regolazione altezza.
Plastic frame, painted steel base on wheels, height regulation.
Coque en polyéthylène, élément bas en acier verni sur roulettes, réglage hauteur.
Sitzschale aus Kunststoff, Gestell aus lackiertem Stahl auf Rollen, höhenverstellbar.
Armazón de plástico, mueble bajo de acero pintado sobre ruedas, con regulación de la altura.



.. 60 / 60 180/88

STRATO

Sedia multistrato rivestita, struttura metallo verniciata bianco.
Chair in upholstered plywood, metal structure varnished in white.
Chaise multiplis revêtu, structure métal vernie blanche.
Stuhl aus beschichtetem Schichtholz, Gestell aus weiß lackiertem Metall.
Silla de multicapa revestida, estructura de metal pintado blanco.



.. 60 / 60 182/90

172

WELL

Scocca polipropilene, base in metallo verniciata su ruote, regolazione altezza.
Structure in polypropylene, base in varnished metal on wheels, height adjustment.
Coque polypropylène, élément bas en métal verni sur roulettes, réglage hauteur.
Sitzschale aus Polypropylen, Gestell aus lackiertem Metall auf Rollen, in der Höhe verstellbar.
Armazón de polipropileno, base de metal pintada sobre ruedas, regulación de la altura.



.. 57 / 54 175/83

VELA

Sedile imbottito, schienale e struttura plastica grigia.
Padded seat, backrest and structure in grey plastic.
Siège rembourré, dossier et structure plastique grise.
Sitz gepolstert, Rückenlehne und Gestell aus grauem Kunststoff.
Asiento acolchado, respaldo y estructura de plástico gris.



.. 57 / 57 175/84

BLOOM

Base in metallo verniciata su ruote, regolazione altezza.
Base in varnished metal on wheels, height adjustment.
élément bas en métal verni sur roulettes, réglage hauteur.
Gestell aus lackiertem Metall auf Rollen, in der Höhe verstellbar.
Base de metal pintada sobre ruedas, regulación de la altura.



.. 62 / 62 173/83

173

SEDIE

CHAIRS / CHAISES / STÜHLE / SILLAS

POLI

Sedia con scocca polipropilene, base in acciaio verniciato bianco.
Chair with structure in polypropylene, base in white varnished steel.
Chaise avec coque polypropylène, élément bas en acier verni blanc.
Stuhl mit Sitzfläche aus Polypropylen, Gestell aus weiß lackiertem Stahl.
Silla con armazón de polipropileno, base de acero pintado blanco.



-- 44 / 50 175/83



-- 44 / 50 175/83

POCKET

Sedia con scocca in polipropilene, impilabile.
Chair with structure in polypropylene, stackable.
Chaise avec coque en polypropylène, empilable.
Stuhl mit Schale aus Polypropylen, stapelbar.
Silla con armazón de polipropileno, apilable.



-- 42 / 41 182



174

SET

Sedia con sedile e schienale polipropilene o imbottito e rivestito in tessuto, regolazione altezza.
Chair with seat and backrest in polypropylene or padded and upholstered in fabric, height adjustment.
Chaise avec siège et dossier polypropylène ou rembourré et revêtu en tissu, réglage en hauteur.
Stuhl mit Sitzfläche und Rückenlehne aus Polypropylen oder gepolstert und mit Stoffbezug, in der Höhe verstellbar.
Silla con asiento y respaldo de polipropileno o acolchado y tapizado de tejido, regulación de la altura.



-- 42 / 42 173/82



-- 42 / 42 173/82

175

WALLPAPERS

CARTA DA PARATI



176

Realizzate con stampa UV HD su poliestere tessuto-non-tessuto (finitura grana fine). Fornita in rotoli larghi 60 cm. Resistente a graffi e lavabile con spugna umida (non abrasiva).

WALLPAPER. UV HD printed on woven-non-woven polyester (fine grain finish). Supplied in 60cm wide rolls. Scratch resistant and washable with a damp sponge (non-abrasive).

PAPIER MURAL. Réalisés avec impression UV HD sur polyester tissu-non tissu (finition grain fin). Fournie en rouleaux de 60 cm de largeur. Résistant aux rayures et lavables avec éponge humide (non abrasive).

TAPETEN. Mit hochauflösendem UV-Druck auf Polyestervlies (feinkörnige Struktur). Lieferung in 60 cm breiten Rollen. Kratzfest und mit feuchtem Schwamm abwaschbar (nicht scheuerend).

PAPEL PINTADO. Realizado con impresión UV HD sobre poliéster tejido no tejido (acabado grano fino). Suministrado en rollos de 60 cm de ancho. Resistente a los arañazos y lavable con una esponja húmeda (no abrasiva).



BUBBLE



CIRCLE

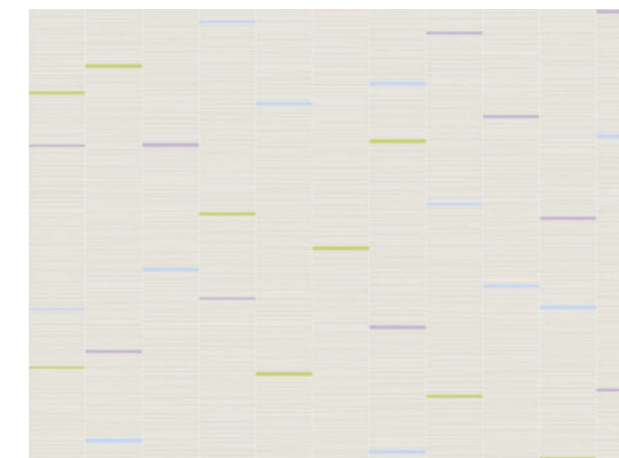

RANDOM 1

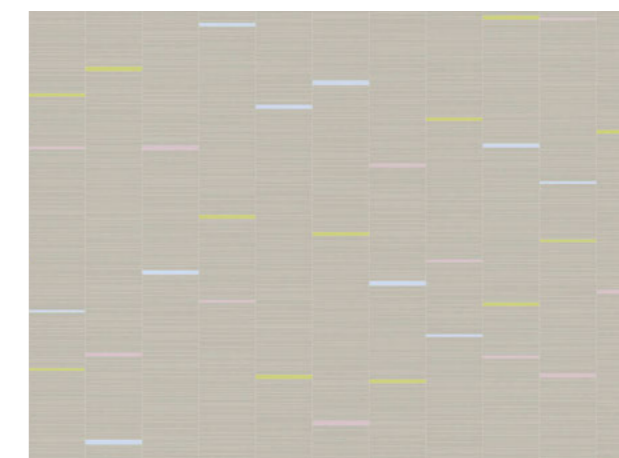

RANDOM 2

177

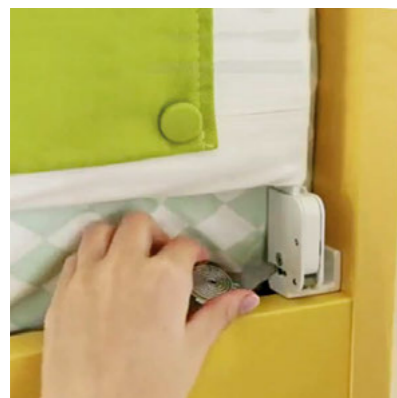

PROTEZIONE LETTI A CASTELLO CERTIFICATA

Protezione conforme alla norma europea UNI EN 747-1 relativa alla sicurezza.

CERTIFIED BUNK BEDS PROTECTION. The protection is compliant with UNI EN 747-1 about safety.

PROTECTION LITS SUPERPOSÉS CERTIFIÉE. Protection conforme à la norme européenne UNI EN 747-1 relative à la sécurité.

ZERTIFIZIERTER SCHUTZ FÜR ETAGENBETTEN. Der Schutz erfüllt die europäische Norm UNI EN 747-1 zur Sicherheit.

PROTECCION PARA LITERAS CERTIFICADA. Protección conforme con la norma europea UNI EN 747-1 relativa a la seguridad.



CASSETTI CON GUIDE A SCOMPARSA

Guida con sistema decelerante integrato (estrazione parziale e totale) che ammortizzando la chiusura evita l'eventuale schiacciamento delle dita.

DRAWERS WITH BUILT-IN RAILS. Rails with built-in deceleration system (partial or total pullout mechanism) that cushions the closing action avoiding possible finger crushing.

TIROIRS AVEC COULISSES ESCAMOTABLES. Coulisse avec système décélérant intégré (extraction partielle et totale) qui en amortissant la fermeture évite l'éventuel coincement des doigts.

SCHUBKÄSTEN MIT VERDECKT LIEGENDEN FÜHRUNGEN. Führung mit integriertem Dämpfungssystem (Teil- und Vollauszug). Für sanftes Schließen, um sich nicht die Finger einzuklemmen.

CAJONES CON GUIAS OCULTAS. Guía con sistema ralentizado integrado (extracción parcial y total) que amortiguando el cierre impide el posible aplastamiento de los dedos.

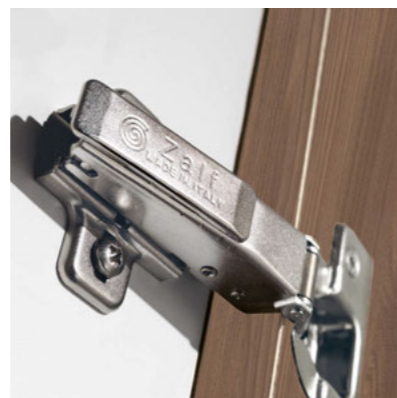

CERNIERE CON SISTEMA DECELERANTE

Ante dotate di cerniere con sistema decelerante integrato con regolazione in altezza, larghezza e profondità.

HINGES WITH DECELERATION SYSTEM. Hinged doors feature a built-in deceleration system with height, width and depth adjustment.

CHARNIÈRES AVEC SYSTÈME DÉCÉLERANT. Portes dotées de charnières avec système décélérant intégré et réglage en hauteur, largeur et profondeur.

SCHARNIERE MIT DÄMPFUNGSSYSTEM. Türen mit Scharnieren und integriertem Dämpfungssystem, in Höhe, Breite und Tiefe verstellbar.

BISAGRAS CON SISTEMA RALENTIZADO. Puertas equipadas con sistema ralentizado integrado con regulación de la altura, del ancho y de la profundidad.

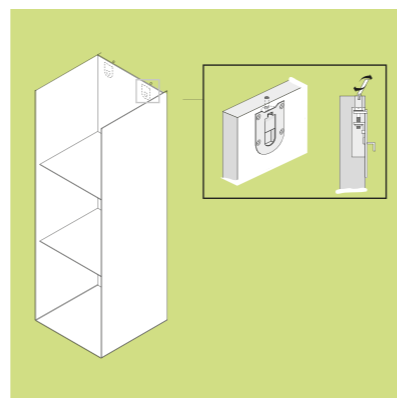

ATTACCAGLIE A SCOMPARSA CON ANTISGANCIAMENTO

Pensili a muro con attaccaglie a scomparsa, dotati di regolazione in altezza, larghezza, profondità e di sistema antisganciamento accidentale.

BUILT-IN HOOK-IN DEVICES WITH A SAFETY SYSTEM AGAINST UNFASTENING. Wall units feature built-in hook-in devices, equipped with height, width and depth adjustment and with a safety system against accidental unfastening.

FIXATIONS ESCAMOTABLES AVEC ANTI-DÉCROCHEMENT. Éléments hauts au mur avec fixations escamotables, dotés de réglage en hauteur, largeur, profondeur et de système anti-décrochement accidentel.

VERDECKT LIEGENDE BEFESTIGUNGEN MIT AUSHAKSICHERUNG. Wandschränke mit verdeckt liegenden Befestigungen, in Höhe, Breite und Tiefe verstellbar und mit Aushaksicherung.

GANCHOS OCULTOS CON SISTEMA ANTIDESENGANCHE. Muebles colgantes de pared con ganchos ocultos, equipados con regulación de la altura, del ancho, de la profundidad y con sistema antidesenganche accidental.

TUTELA DELLA SALUTE

QUALITÀ, SICUREZZA, ECOLOGIA, DESIGN SOSTENIBILE COME CULTURA DI PRODOTTO

HEALTH PROTECTION. TOTAL QUALITY AND SAFETY ARE INTEGRAL PART OF OUR PRODUCT CULTURE.
PROTECTION DE LA SANTE. QUALITÉ ET SÉCURITÉ TOTALE COMME CULTURE DE PRODUIT
GESUNDHEITSSCHUTZ. ABSOLUTE QUALITÄT UND SICHERHEIT ALS PRODUKTKULTUR.
TUTELA DE LA SALUD. CALIDAD Y SEGURIDAD TOTAL COMO CULTURA DE PRODUCTO.

ECOSOSTENIBILITÀ E RISPETTO DELLA NATURA



L'ecopannello a bassissima emissione di formaldeide è conforme al regolamento "CARB Fase 2" in particelle di legno con bassissime emissioni di formaldeide (-35% rispetto alla normativa vigente classe E1). È ricavato dal riutilizzo di materiale legnoso, nella logica del rispetto della natura e del consumatore finale. Il sistema di riscaldamento delle strutture Zalf è a combustori a biomasse che eliminano completamente le esalazioni e non contribuiscono all'effetto serra. Inoltre tutti gli imballi sono riciclabili al 100%.

ECO-SUSTAINABILITY AND RESPECT FOR NATURE. The eco-panel with a very low formaldehyde emission is compliant with the regulation "CARB Phase 2" about wood particles with very low formaldehyde emissions (-35% compared with current regulations class E1). It is made with recycled wooden materials, focusing on respect for nature and final consumers. The heating system of Zalf structures comprises biomass burners that totally eliminate emissions and do not contribute to global warming. Furthermore all packing materials are 100% recyclable.

ÉCOSOUTENABILITÉ ET RESPECT DE LA NATURE. L'ecopanneau à très faible émission de formaldéhyde est conforme au règlement "CARB Phase 2" en particules de bois avec de très faibles émissions de formaldéhyde (-35% par rapport à la réglementation en vigueur classe E1). Il est obtenu par la réutilisation de matériau ligneux, dans la logique du respect de la nature et du consommateur final. Le système de chauffage des structures Zalf est à combusteurs à biomasse qui éliminent complètement les exhalaisons et ne contribuent pas à l'effet de serre. De plus, tous les emballages sont recyclables à 100%.

UMWELTVERTRÄGLICHKEIT UND RESPEKT FÜR DIE NATUR. Die Öko-Holzspanplatte mit sehr niedriger Formaldehydemission erfüllt die Bestimmungen von "CARB Fase 2" mit sehr geringer Formaldehydemission hergestellt [35% Weniger als die für Klasse E1 geltende Norm]. Sie wird aus wiederverwertetem Holzmaterial hergestellt, mit Rücksicht auf die Natur und den Endkunden. Die Heizsysteme der Gebäude von Zalf arbeiten mit Biomasse-Heizkesseln, wodurch keine Verunreinigungen freigesetzt werden und der Treibhauseffekt nicht gefördert wird. Ferner sind alle Verpackungen zu 100% recycelbar.

ECOSOSTENIBILIDAD Y RESPETO DE LA NATURALEZA. El ecopanel de bajísima emisión de formaldehído está conforme con el reglamento "CARB Fase 2" de partículas de madera con bajísimas emisiones de formaldehído [-35% con respecto a la Norma Vigente Clase E1]. Se obtiene por material leñoso reciclado, en la lógica del respeto de la naturaleza y del consumidor final. El sistema de calentamiento de las estructuras de Zalf se realiza mediante cámaras de combustión por biomasa que eliminan las exhalaciones y no contribuyen al efecto serra. Además todos los embalajes son reciclables al 100%.

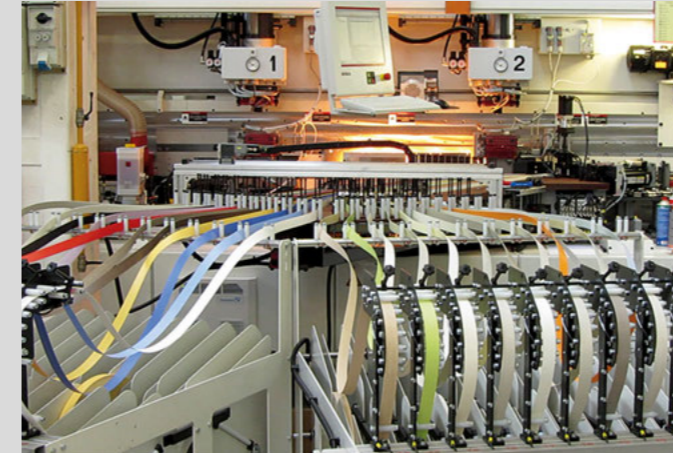

ZALF: KNOW HOW E RICERCA CONTINUA COME STORIA CREATIVA

KNOW-HOW AND CONTINUOUS RESEARCH IS OUR CREATIVE STORY.
SAVOIR-FAIRE ET RECHERCHE CONTINUE COMME HISTOIRE CRÉATIVE.
KNOW-HOW UND KONTINUIERLICHE FORSCHUNG ALS KREATIVE GESCHICHTE.
KNOW HOW E INVESTIGACION CONTINUA COMO HISTORIA CREATIVA.

RICERCA PROGETTUALE E INNOVAZIONE

Zalf sviluppa la propria cultura progettuale con il linguaggio dell'innovazione: nuove idee diventano prodotti capaci di integrarsi con quelli esistenti, ampliando così al massimo le possibilità di personalizzazione. Il design originale non segue le mode e dura nel tempo.

DESIGN RESEARCH AND INNOVATION. Zalf develops its design culture through the language of innovation: new ideas are turned into products that can integrate with existing ones, thus extending customisation opportunities. Original design is durable and does not slavishly follow fashion.

RECHERCHE DE PROJET ET INNOVATION. Zalf développe sa propre culture de projet avec le langage de l'innovation: de nouvelles idées deviennent des produits en mesure de s'intégrer avec ceux qui existent, elles élargissent ainsi au maximum les possibilités de personnalisation. Le design original ne suit pas les modes et dure dans le temps.

PLANUNGSFORSCHUNG UND INNOVATION. Die Planungskultur von Zalf überzeugt durch Innovation: neue Ideen werden zu Produkten, die sich in bestehende Artikel einfügen, wodurch den individuellen Gestaltungsmöglichkeiten keine Grenzen gesetzt sind. Originelles Design ist modeunabhängig und zeitlos.

INVESTIGACION PROYECTUAL E INNOVACION. Zalf desarrolla su cultura proyectual con el lenguaje de la innovación: nuevas ideas se convierten en productos capaces de integrarse en los ya existentes, ampliando al máximo las posibilidades de personalización. El diseño original no sigue las modas y dura en el tiempo.

TECNOLOGIE ESCLUSIVE ED ECOSOSTENIBILI

Azienda certificata UNI EN ISO 9001, Zalf è sempre attenta all'innovazione industriale nel massimo rispetto dell'ambiente: tecnologie d'avanguardia garantiscono maggiori performance di prodotto, come ad esempio i collanti poliuretano dalle eccellenti proprietà adesive.

EXCLUSIVE, ECO-SUSTAINABLE TECHNOLOGIES. A UNI EN ISO 9001 certified company, Zalf pays careful attention to industrial innovation that is environmentally friendly: high product performance is guaranteed by avant garde technologies, such as, for example, excellent polyurethane adhesives.

TECNOLOGIES EXCLUSIVES ET ÉCOSOUTENABLES. Entreprise certifiée UNI EN ISO 9001, Zalf est toujours attentif à l'innovation industrielle dans le respect de l'environnement: des technologies d'avant-garde garantissent de meilleures performances de produit, comme par exemple les colles de polyuréthane aux excellentes propriétés adhésives.

EXKLUSIVE UND NACHHALTIGE TECHNOLOGIEN. Das nach UNI EN ISO 9001 zertifizierte Unternehmen Zalf verbindet industrielle Innovation stets mit höchstem Respekt für die Umwelt: fortschrittliche Technologien garantieren bessere Leistungsmerkmale der Produkte, wie beispielsweise die Polyurethankleber mit optimalen Haftigenschaften.

TECNOLOGIAS EXCLUSIVAS Y ECOSOSTENIBLES. Empresa certificada UNI EN ISO 9001, Zalf está siempre atenta a la innovación industrial en el máximo respeto del medio ambiente: tecnologías de vanguardia garantizan mayores prestaciones del producto, como por ejemplo las colas poliuretánicas de extraordinarias propiedades adhesivas.

FINITURE CHE RIPRODUCONO L'ESSENZA DEL LEGNO

La ricerca costante di materiali innovativi dal carattere forte e dalla praticità immediata, ha portato alla realizzazione dei termostrutturati, finiture capaci di riprodurre perfettamente, sia alla vista che al tatto, le migliori essenze del legno.

FINISHES THAT REPRODUCE THE ESSENCE OF WOOD. A constant search for practical, innovative materials with personality has led to the creation of the thermostructured finish that reproduces perfectly both the appearance and feel of the best wood species.

FINITIONS QUI REPRODUISENT L'ESSENCE DU BOIS. La recherche constante de matériaux innovatifs au caractère fort et à l'aspect pratique immédiat, a mené à la réalisation des thermostructurés, des finitions en mesure de reproduire parfaitement, aussi bien à la vue qu'au toucher, les meilleures essences du bois.

ÖBERFLÄCHEN IN HOLZOPTIK. Die kontinuierliche Forschung nach innovativen, ausdruckstarken und praktischen Materialien führte zur Entwicklung von thermostrukturierten Oberflächen, die edelste Holzarten sichtbar und fühlbar perfekt nachbilden.

ACABADOS QUE REPRODUCEN LA MADERA. La investigación constante de materiales innovadores de carácter fuerte y de funcionalidad inmediata, ha llevado a la realización de los termoestructurados, acabados capaces de reproducir perfectamente, tanto a la vista como al tacto, las mejores maderas.



Zalf
Sistema Link System con ante vetro Teca
design R&S Zalf e Roberto Gobbo.

Euromobil
Cucina FiloAntis33 design R&S Euromobil e Roberto Gobbo.

Désirée
Divano Savoye e poltrone Koster design Marc Sadler.
Tavolini Sabi design Setsu & Shinobu Ito.
Tappeto Baobab design R&S Désirée.

A Total Home project featuring high quality, coordinated, unique design: Zalf living, night, young, Euromobil kitchen and living and Désirée sofas, armchairs and beds.

Un projet de maison total de design de haut niveau coordonné et distinctif Zalf jour, nuit, enfants et adolescents, Euromobil cuisines et living et Désirée canapés, fauteuils et lits.

Ein ganzheitliches wohnprojekt mit abgestimmtem und gehobenem charakteristischem design Zalf wohnräume, schlafräume, kinder-und jugendzimmer, Euromobil küchen und wohnräume und Désirée sofás, sessel und betten.

Un proyecto de vivienda total de alto diseño coordinado y distintivo Zalf día, noche, niños y chicos, Euromobil cocinas y living y Désirée sofás, butacas y camas.



TOTALHOMEDESIGN

UN PROGETTO DI CASA TOTALE
DI ALTO DESIGN COORDINATO E DISTINTIVO
ZALF LIVING, NIGHT, YOUNG,
EUROMOBIL CUCINE, LIVING
E DÉSIRÉE DIVANI, POLTRONE E LETTI

Concept and Graphic Design:
valentinicesarottiassociati

Photo:
Ezio Prandini
Federico Zattarin

Image:
studioEIKE

Styling:
Luigina Piloni

Colour separation:
CD Cromo

Print:
Grafiche Antiga

Si ringrazia:
A+A lab
Cecchi & Cecchi
Coraxart
House Doctor
Intueriligt

**Le poltrone e le poltroncine presenti
nel catalogo sono di Désirée**

CAT. 0717



Sport
Design
Arte



gruppoeuromobil.com



Zalf Mobili Componibili SpA
Via Marosticana, 9
31010 Maser-TV-Italy
Tel. +39 04239255
Fax +39 0423565866
numero verde 800 011019



**Scopri i contenuti extra
con l'app Gruppo Euromobil.**
Scarica la nuova app del
Gruppo Euromobil
dall'Apple Store
o da Google Play.

**Check out the extra content
with Gruppo Euromobil app.**
Download the new
Gruppo Euromobil app
from Apple Store
or Google Play.

Zalf, al fine di migliorare le caratteristiche tecniche e qualitative della sua produzione, si riserva il diritto di modificare in tutto o in parte il contenuto del presente catalogo anche senza preavviso.

Zalf, at the end of improving the technical and qualitative characteristics of production, reserve the right to modify entirely or partially the content of the present catalogue even without notice.

Zalf, au fin de améliorer les caractéristiques techniques et qualitatives de son produit, se réserve le droit de modifier le contenu en tout ou en partie du ce catalogue aussi sans préavis.

Um die technischen und qualitativen Merkmale der Produktion zu verbessern, behält sich Zalf, das Recht vor, den Inhalt des vorliegenden Katalogs ohne Vorankündigung zur Gänze oder teilweise abzuändern.

Zalf, a fin de mejorar sus características y calidad de la producción, se reserva el derecho de hacer cambios completos o parciales en el contenido de este catálogo, incluso sin previo aviso.



Il marchio FSC® identifica prodotti contenente legno proveniente da foreste gestite in maniera corretta e responsabile, secondo rigorosi standards ambientali, sociali ed economici. La foresta di origine è stata controllata e valutata in maniera autonoma in conformità a principi stabiliti ed approvati dal Forest Stewardship Council®.

Zalf SpA, ha scelto per questo catalogo carta certificata FSC®. The FSC® brand identifies products coming from responsible tree farming, according to very strict environmental, social and economic standards. The forests the wood comes from have been independently controlled and assessed in conformity with the principles established and approved by the Forest Stewardship Council®. Zalf SpA, has used FSC® certified recycled paper for this catalogue.

Carta: x-per premium white